



.....
PRODUKTOVÝ
KATALOG

Product catalogue
.....

Úchytky a věšáky
Handles and hooks

2015



Uvedené obrázky, dekory a fotografie jsou pouze ilustrační. Vydavatel si vyhrazuje právo na tiskové chyby, chyby v sazbě a technické změny.

Illustrative pictures and photos. Publisher reserves the right to press and typographical errors and technical changes.

OBSAH / CONTENT



Kovové úchytky
Metal cabinet pulls

11



Knopky
Metal knobs

109



Zápustné úchytky
Recessed handles

137

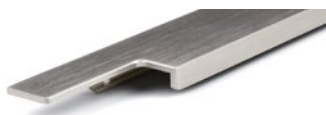

Narážecí profily
Aluminium edge banding handles

153



Rustikální úchytky
Classical handles

161



Dřevěné úchytky
Wooden handles

195



Plastové úchytky
Plastic handles

203



Věšáky
Furniture hooks

217



Příslušenství
Accessories

263

Veškeré uvedené rozměry jsou v milimetrech / all dimensions are in millimetres.

PŘEHLED ÚCHYTEK A VĚŠÁKŮ

SUMMARY OF HANDLES AND HOOKS

Kovové úchytky



UMBERTO 12



ROMA 13-14



BARI 14-15



CRISTINA 15-16



BEATRICE 16

NOVINKA



PECA 17

NOVINKA



TACA 18-19



MODENA 19-20



VERONA 20-21



PORTA 21-23



KOFU 23-24



ENA 24-25

NOVINKA



ACARA 25



CUBIC 26



CUBIC 26



RAKA 26



NAGISA 27



TENGA 27



FOKA 28



JOSA 28



SOSA 29



LACATA 29-30



NAKANA 30-31



DAVID 31



KAMOTA 32



MARINA 32



SAKATA 32



OMONO 33



KAZUNO 33-34



TOWADA 34



MUTA 35



OGA 35-36



STIRO 36

NOVINKA



SCALA 37

NOVINKA



MARCA 38



HARUNA 38



ASAMA 39



ROMINA 40



ISA 40



AIRA 41



DARA 41



MUSINA 41



SITA 42



EBINA 42



ENOKA 42



RUSA 43



KAMA 43



HRAZDA 12 44-46



PENKA 47



PORINA 47



MORINA 48



RUMO 48



DALO 48



RITTO 49-50

NOVINKA



LUCA 51-52

Kovové úchytky



MENUSA 52

NOVINKA



MARIBA 59



GENEDA 67



UMORA 79



LIKANO 90



ULICA 52-53



MALADA 59-60



SAKITA 68



HALENA 80



WAKANO 90



RODOSO 53



FUKOL 60



PELENA 69



CEMUNA 81



TALOMA 90



KAMINA 53-54



KETA 60



PIOMBINA 69-72



RESINA 81

NOVINKA



HYTECH 91



FORO 54



LUDA 61



ANITA 72-75



FIONA 81-82



ZUZANA 91



PAMIL 54-55



UNESA 62



OLIFO 76



BETA 83-85



PETARO 91



SELENA 55



ILUNA 63



TIMINA 76



IDA 85-86



ASUDA 92



ROTONDA 56



PENETA 64



UROSO 76-77



RUONA 86-87



VOLENA 92



PIEGATA 56-57



IBIKA 64



PRIMA 77-78



KEWINA 88



GREENDA 92



SEKOL 58



PALIN 65



LOMINA 78-79



TORINO 89



MERITA 93



MITIDA 58



NOMINA 66



BESINA 79



JAKOTO 89

NOVINKA



ISOLA 93-94

PŘEHLED ÚCHYTEK A VĚŠÁKŮ

SUMMARY OF HANDLES AND HOOKS

Kovové úchytky

	
PATRIC 94-95	ELIPSE 100
	
ZITO 95	ARGUS 101
	
SEMA 95	ARGUS X 101-102
	
KETINA 96	CARINA 102
	
LOKUTA 96	DADA 028 103
	
KVADRA 97	DADA 050 103-104
	
BELUGA 97-98	DADA 100 105-106
	
PADOVA 99	ENZA 106
	
CORDOBA 99	ENZA 107
	
RECIFE 99-100	KUTTA 107
	
SANTIAGO 100	KUTTA 107

Kovové knopky

		
RUOTA 108	FUNGO 110	PORESA 121-122
		
RUOTA 108	TOMIC 110-111	SETAN 122-123
		
OSAKA 108	UKUDA 111-112	RAPPA 123
		
RUZA 113-114	TUCANA 123	
		
JOTA 114-116	LUNA 124	
		
GALKA 116-117	BELUGA 124	
		
IROKO 117	FORO 125	
		
RUDA 118	WHALE 125	
		
TURIA 118-119	OTA 126	
		
MARUSA 120	ZOLA 126	
		
MATEO 121	TINTO 126-127	

Kovové knoflíky

	DADA 060	127-128
	BLOCK	128
	FRAME	128
	RITTO	129-130
	TACA	130-131
	PRISMA	132
	VINTAGE S	132-133
	VINTAGE O	133-134
	VINTAGE ST	134-135
	VINTAGE RT	135
	VINTAGE R	135

SEKOL

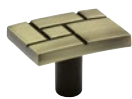

136

Zápustné úchytky

	PISTA	138
	NOVINKA RAPID	138
	ORINOCO	139
	UNTA	139
	MALUKA	139-140
	NOVINKA NAVE	140
	NOVINKA MALENA	141-142
	CONCAVA	142-143
	RULIDA	143
	COMOLA	143
	SWIFT	144

	ILITA	145
	PESARA	145-146
	MADRID	146
	CESARO	147-148
	ANETTA	148
	UTARA	149
	NOVINKA PORTOS L	149
	MUDA	150
	MANE	150
	AVOCA	151
	KANIVA	152











Narážecí profily





	TEPPO	154-155
	PAOLO	155
	FANO	155
	JUVIO	156
	NOVINKA RAMARA	156-157
	TORINO	157
	PIANO	157
	FLATA	158
	NOVINKA LUCATA	158-159
	LUNGO	160

PŘEHLED ÚCHYTEK A VĚŠÁKŮ





SUMMARY OF HANDLES AND HOOKS

Rustikální úchytky

	DERBY	162
	SULKY	163
	KENTUCKY DS	164
	KENTUCKY	165
	TORONTO DS	166
	TORONTO	167
	CORSICA	168
	SHELL	169-170
	LINEA	171
	STAMP	172
	COTTAGE	173

	COTTAGE	173
NOVINKA 	TUVOLA	173
	TUVOLA	174
	SERENA	174-175
	SERENA	174-175
	URICA	175
	VIRELLA	176
	VIRELLA M	176
	VIRELLA L	176
NOVINKA 	DORA	177-178
	VALI	178

NOVINKA 	TOMO	179
NOVINKA 	TOMO	179-180
NOVINKA 	HRAZDA 23	181
	VICTORIA	182
	VICTORIA	182-183
	CARAT	183
	ULIKO	183
	COUNTRY	184
	COUNTRY	185
	COUNTRY	185-186
	GIPA	186-189

	GIPA	188-191
	SARA	191
	TECCA	192
	STOCKHOLM	192-193
	STOCKHOLM	193-194

Dřevěné úchytky

	BALA	196
	MUNA	196
	SOLA	196
	JACEK	197
	ADAM	197
	OLZA	197
	JURA	198
	MATRA	198-199
	BERGA	199-201
	PIERA	202
	FILA	202

Plastové úchytky

NOVINKA



P435 204

NOVINKA



P431 205

NOVINKA



P603 206-207

NOVINKA



M306 207-208



FIORA 209-210



PIAZA 210



PALLA 211



STELA 212



FIŠK 212



CHAT 212



RANA 213



PERCHA I 213



PERCHA 213



PERCHA IV 214



PERCHA II 214



TREN I 215



TREN 215



TREN IV 216

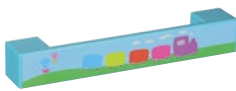

TREN II 216

Věšáky



DONA 218



BELLUNA 219



BELLUNA XL 220



HONZA XL 221



HONZA 221-222



IWO 222



ERIC 223-224



PERA 224



ROSA 225



VICTORY 225-226



FRANCA 226-227



DORIS 227-228



DYAN 228-229



ROTOLO 229



TARASA 229-230



ROBERTO 230



MELA 231



ROKOS 231



DAX 232



WA 01 233



TELUS 233-234



ILAN 234-235



LUGO 235-236



DAVOS 237-238



PETROS 238-240



CARLOS 240-241



DAREC XL 242



DAREC 243



MARCEL XL 244



MARCEL S 245



TAMOS 246



TRIAS 246-247



RAPALLO 247-248

PŘEHLED ÚCHYTEK A VĚŠÁKŮ

SUMMARY OF HANDLES AND HOOKS

Věšáky



UNICO 249-250



FERA 250

NOVINKA



EMIL 250-251



CARPO 251-252



LIVORNO 252-253



LERICO 254



MUSO 255



MURERO XL 256



MURERO 256-257



ORIO XL 257



ORIO 257



RUBICO XL 258-259



RUBICO 259-261



RUZA 261-262



RITTO 262



TOWELO 262



1

Kovové úchytky
Metal cabinet pulls



KOVOVÉ ÚCHYTKY

METAL CABINET PULLS

UMBERTO

Chrom / polished chrome

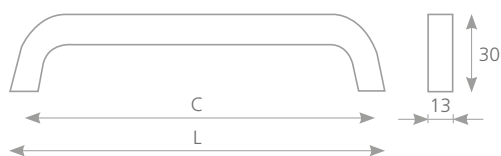

Kód / art.	C	L
192365	192	214
192366	256	278
192367	320	342
192368	448	470

UMBERTO

Imitace nerezi / stainless steel imitation

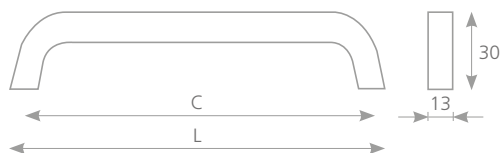

Kód / art.	C	L
192369	192	204
192370	256	268
192371	320	332
192372	448	460



ROMA

Imitace nerezi

Stainless steel imitation

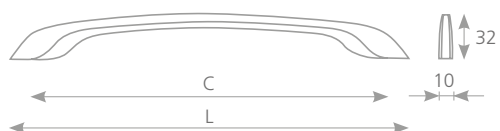

Kód / art.	C	L
192327	192/224	246
192329	288/320	346

KOVOVÉ ÚCHYTKY

METAL CABINET PULLS

ROMA

Chrom / polished chrome

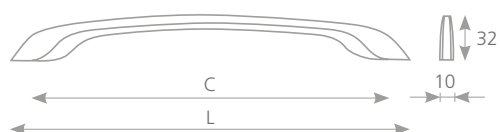

Kód / art.	C	L
192326	192/224	246
192328	288/320	346

BARI

Chrom / imitace nerezi
Polished chrome / stainless steel imitation

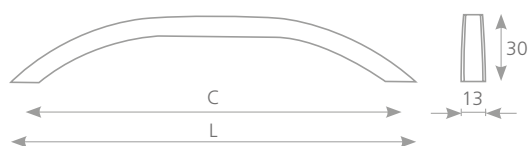

Kód / art.	C	L
192330	192	205
192331	320	334
192332	480	494

BARI

Chrom / bílá
Polished chrome / white

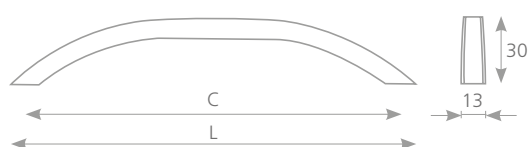

Kód / art.	C	L
192333	192	205
192334	320	334
192335	480	494

KOVOVÉ ÚCHYTKY

METAL CABINET PULLS

BARI

Chrom / broušený chrom
Polished chrome / matt chrome brushed

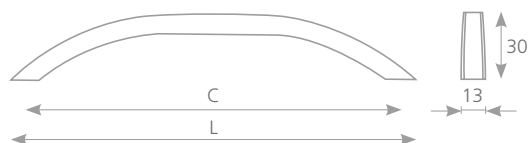

Kód / art.	C	L
192336	192	205
192337	320	334
192338	480	494

CRISTINA

Chrom / imitace nerezí
Polished chrome / stainless steel imitation

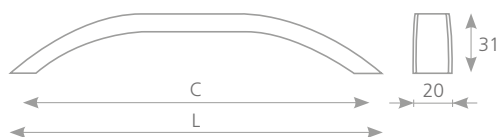

Kód / art.	C	L
192339	192	206
192340	320	334
192341	480	494
192342	672	686

CRISTINA

Chrom / broušený chrom
Polished chrome / matt chrome brushed

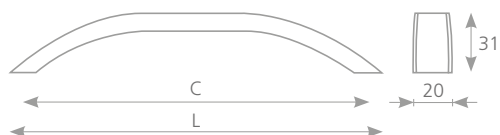

Kód / art.	C	L
192343	192	206
192344	320	334
192345	480	494
192346	672	686

KOVOVÉ ÚCHYTKY

METAL CABINET PULLS

CRISTINA

Chrom / bílá
Polished chrome / white

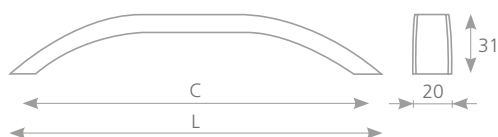

Kód / art.	C	L
192347	192	206
192348	320	334
192349	480	494
192350	672	686

BEATRICE

Chrom / imitace nerezí
Polished chrome / stainless steel imitation



Kód / art.	C	L
192351	224	236
192352	320	332

BEATRICE

Chrom / broušený chrom
Polished chrome / matt chrome brushed



Kód / art.	C	L
192353	224	236
192354	320	332

KOVOVÉ ÚCHYTKY

METAL CABINET PULLS

PECA

Chrom lesklý / imitace nerezí
Polished chrome / stainless steel imitation



Kód / art.	C	L
225070	128	142
225071	192	206
225072	256	270

PECA

Chrom lesklý / hliník
Polished chrome / aluminium



Kód / art.	C	L
225067	128	142
225068	192	206
225069	256	270

PECA

Chrom lesklý / bílá
Polished chrome / white



Kód / art.	C	L
227260	128	142
227261	192	206
225066	256	270

KOVOVÉ ÚCHYTKY

METAL CABINET PULLS

TACA

Chrom lesklý / hliník

Polished chrome / aluminium



knopka TACA (str. 131)
knob TACA (pg. 131)



Kód / art.	C	L
246016	160	176
246017	256	272
246018	384	400

TACA

Chrom lesklý / bílá

Polished chrome / white



knopka TACA (str. 130)
knob TACA (pg. 130)



Kód / art.	C	L
246012	160	176
246013	256	272
246014	384	400

KOVOVÉ ÚCHYTKY

METAL CABINET PULLS

TACA

Chrom lesk / imitace nerezi

Polished chrome / stainless steel imitation



knopka TACA (str. 130)
knob TACA (pg. 130)



Kód / art.	C	L
246020	160	176
246021	256	272
246022	384	400

MODENA

Chrom / hliník

Polished chrome / aluminium

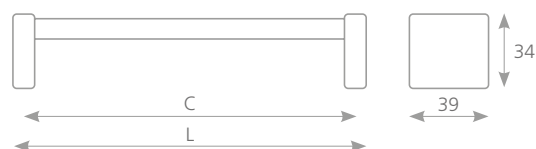

Kód / art.	C	L
195143	128	138
195145	160	170
195147	192	202
195149	224	234
195151	320	330

Kód / art.	C	L
195153	416	426
195155	512	522
195157	640	650
195159	736	746

KOVOVÉ ÚCHYTKY

METAL CABINET PULLS

MODENA

Chrom / imitace nerezí

Polished chrome / stainless steel imitation

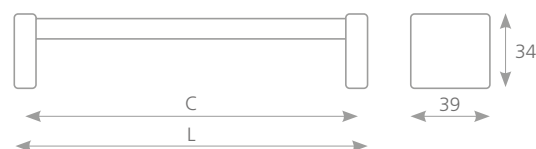

Kód / art.	C	L
195144	128	138
195146	160	170
195148	192	202
195150	224	234
195152	320	330

Kód / art.	C	L
195154	416	426
195156	512	522
195158	640	650
195160	736	746

VERONA

Chrom / hliník

Polished chrome / aluminium



Kód / art.	C	L
195116	128	139
195119	160	171
195122	192	203
195125	224	235
195128	320	331

Kód / art.	C	L
195131	448	459
195134	576	587
195137	672	683
195140	736	747

KOVOVÉ ÚCHYTKY

METAL CABINET PULLS

VERONA

Chrom / imitace nerezí
Polished chrome / stainless steel imitation

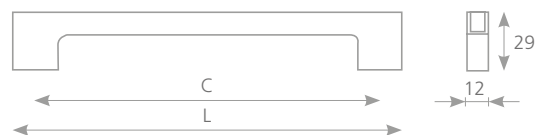

Kód / art.	C	L
195117	128	139
195120	160	171
195123	192	203
195126	224	235
195129	320	331

Kód / art.	C	L
195132	448	459
195135	576	587
195138	672	683
195141	736	747

PORTA

Hliník / aluminium



Kód / art.	C	L
248014	96	108
248015	128	140
248016	160	172
248017	192	204
248018	224	236
248019	256	268
248020	288	300
248021	320	332
248022	384	396
248023	432	444

Kód / art.	C	L
248024	448	460
248025	480	492
248026	544	556
248027	672	684
248028	736	748
248029	768	780
248030	832	844
248031	864	876
248032	960	972

KOVOVÉ ÚCHYTKY

METAL CABINET PULLS

PORTA

Broušený nikel / nickel brushed



Kód / art.	C	L
37909	96	108
37880	128	140
37881	160	172
37882	192	204
37883	224	236
37884	256	268
37885	288	300
37886	320	332
37887	384	396

Kód / art.	C	L
37888	432	444
37889	448	460
37890	480	492
37891	544	556
37892	560	572
37893	672	684
37894	736	748
37895	768	780

PORTA

Imitace nerezí / stainless steel imitation



Kód / art.	C	L
179439	96	108
37980	128	140
37981	160	172
37982	192	204
37983	224	236
37984	256	268
37985	288	300
37986	320	332
37987	384	396

Kód / art.	C	L
179441	432	444
37989	448	460
37990	480	492
37991	544	556
37992	560	572
37993	672	684
37994	736	748
37995	768	780

KOVOVÉ ÚCHYTKY

METAL CABINET PULLS

PORTA

Chrom / polished chrome



Kód / art.	C	L
157786	96	108
157787	128	140
157788	160	172
157789	192	204
157790	224	236
157791	256	268
157792	288	300
157793	320	332
157794	384	396

Kód / art.	C	L
157795	432	444
157796	448	460
157797	480	492
157798	544	556
157799	560	572
157800	672	684
157801	736	748
157802	768	780

KOFU

Satin chrom / hliník
Matt chrome / aluminium



Poznámka: nožky satin chrom, tělo hliník
Note: legs matt chrome, body aluminium

Kód / art.	C	L
37850	128	170
37851	160	202
37852	192	234
37853	256	298
37854	320	362

Kód / art.	C	L
37855	384	426
37856	480	522
37857	544	586
37858	672	714
37859	736	778

KOVOVÉ ÚCHYTKY

METAL CABINET PULLS

KOFU

Broušený nikel / nickel brushed

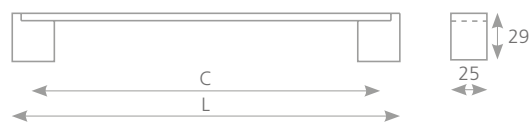

Kód / art.	C	L
37860	128	170
37861	160	202
37862	192	234
37863	256	298
37864	320	362

Kód / art.	C	L
37865	384	426
37866	480	522
37867	544	586
37868	672	714
37869	736	778

ENA

Hliník / aluminium

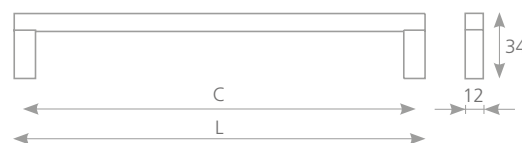

Kód / art.	C	L
36910	128	140
36911	160	172
36912	224	236
36913	320	332

Kód / art.	C	L
36914	432	444
36915	544	556
36916	672	684

KOVOVÉ ÚCHYTKY

METAL CABINET PULLS

ENA

Imitace nerezí / stainless steel imitation

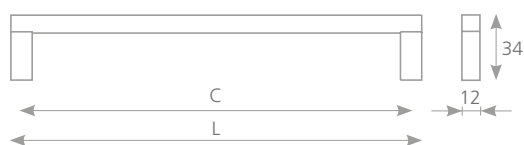

Kód / art.	C	L
36920	128	140
36921	160	172
36922	224	236
36923	320	332
36924	432	444
36925	544	556
36926	672	684

ACARA

Imitace nerezí / stainless steel imitation



Kód / art.	C	L
227217	160	168
227218	224	232
227219	320	328
227220	448	456
227221	544	552
227222	640	648

KOVOVÉ ÚCHYTKY

METAL CABINET PULLS

CUBIC

Imitace nerez / stainless steel imitation

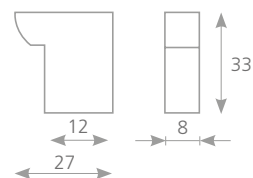

Kód / art.

157570

CUBIC

Imitace nerez / stainless steel imitation



Kód / art.

C

L

157571

128

148

157572

160

180

157573

192

212

157574

224

244

RAKA

Nerez tmavá kartáčovaná
Stainless steel dark brushed

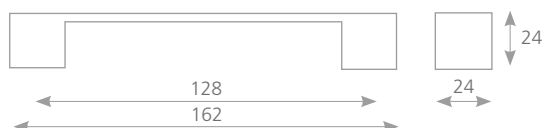

Kód / art.

267243 •

KOVOVÉ ÚCHYTKY

METAL CABINET PULLS

NAGISA

Stříbrná / silver



Kód / art.	C	L
77911	32	51
77912	96	115
77913	128	147
77914	160	179

TENGA

Stříbrná / silver



Kód / art.	C	L
77950	160	179
77952	320	344

TENGA

Imitace nerez / stainless steel imitation



Kód / art.	C	L
77951	160	179
77953	320	344

KOVOVÉ ÚCHYTKY

METAL CABINET PULLS

FOKA

Stříbrná / silver

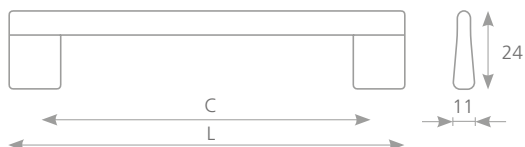

Kód / art.	C	L
77954	160	189
77956	320	349

FOKA

Imitace nerez / stainless steel imitation

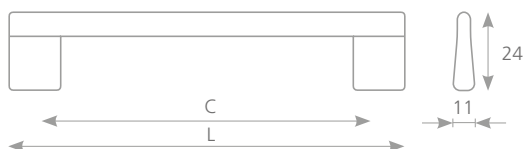

Kód / art.	C	L
77955	160	189
77957	320	349

JOSA

Stříbrná / silver

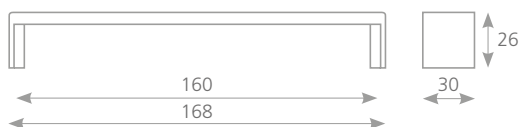

Kód / art.
77910

KOVOVÉ ÚCHYTKY

METAL CABINET PULLS

SOSA

Satin chrom / matt chrome



Kód / art.	C	L
37031	160	190
37033	192	225

SOSA

Broušený nikel / nickel brushed



Kód / art.	C	L
37032	160	190
37034	192	225

LACATA

Imitace nerez / stainless steel imitation



Kód / art.	C	L
227223	128	138
227224	160	170
227225	224	234
227226	320	330
227227	448	458
227228	544	554
227229	640	650

KOVOVÉ ÚCHYTKY

METAL CABINET PULLS

LACATA

Hliník / aluminium

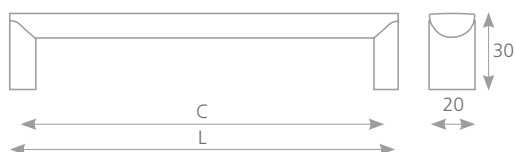

Kód / art.	C	L
227230	128	138
227231	160	170
227232	224	234
227233	320	330
227234	448	458
227235	544	554
227237	640	650

NAKANA

Satin chrom / matt chrome

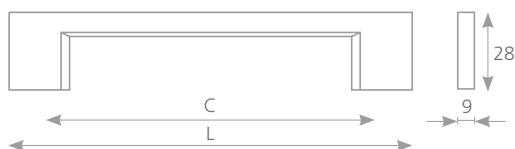

Kód / art.	C	L
37917	64	97
37918	96	129
37919	128	161
37920	192	225
37921	256	289
37922	320	353

NAKANA

Broušený nikel / nickel brushed

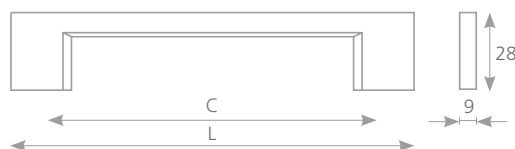

Kód / art.	C	L
37911	64	97
37912	96	129
37913	128	161
37914	192	225
37915	256	289
37916	320	353

KOVOVÉ ÚCHYTKY

METAL CABINET PULLS

NAKANA

Chrom / polished chrome

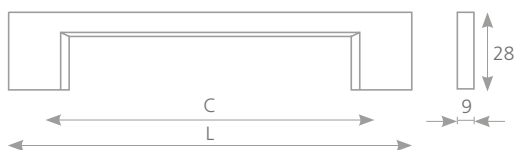

Kód / art.	C	L
202920	64	97
202921	96	129
202922	128	161
202923	192	225
202924	256	289
202925	320	353

DAVID

Imitace nerezi / stainless steel imitation



Kód / art.	C	L
10450	96	104
10451	128	136
10452	160	168
10453	192	200
10454	320	328
10455	448	456

DAVID

Satin chrom / matt chrome

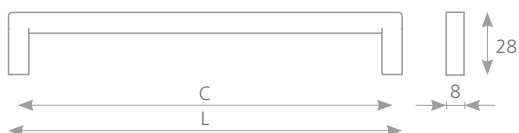

Kód / art.	C	L
10457	192	200
10458	320	328
10459	448	456

KOVOVÉ ÚCHYTKY

METAL CABINET PULLS

KAMOTA

Nerez / stainless steel



Kód / art.	C	L
157717	160	175
157718	192	207
157719	256	271
157720	320	335

MARINA

Nerez / stainless steel



Kód / art.	C	L
203829	128	138
203822	160	170
203823	192	202
203824	224	234

Kód / art.	C	L
203825	320	330
203826	480	490
203827	640	650
203828	736	746

SAKATA

Nerez / stainless steel

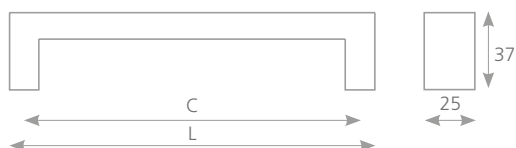

Kód / art.	C	L
157547	160	172
157548	192	204
157549	256	268
157550	320	332

KOVOVÉ ÚCHYTKY

METAL CABINET PULLS

OMONO

Chrom / polished chrome



Kód / art.	C	L
157187	128	137
157185	160	169
226972	320	329

OMONO

Broušený nikl / nickel brushed



Kód / art.	C	L
157188	128	137
157186	160	169
226973	320	329

KAZUNO

Chrom / polished chrome

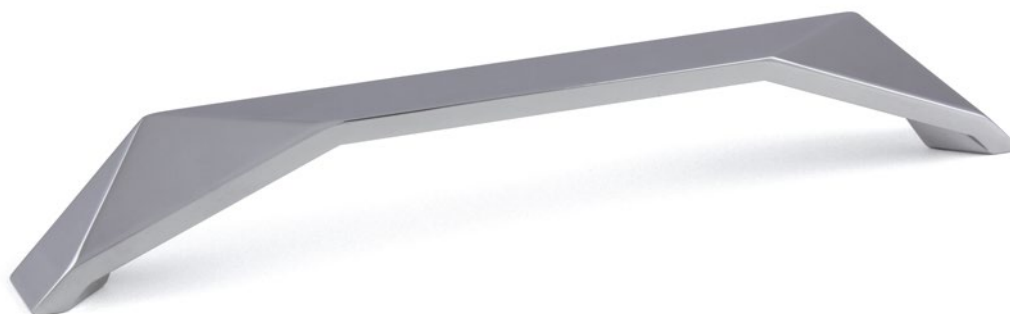

Kód / art.	C	L
157191	192	215

KOVOVÉ ÚCHYTKY

METAL CABINET PULLS

KAZUNO

Broušený nikel / nickel brushed



Kód / art.	C	L
157190	64	99
157192	192	215

TOWADA

Satin chrom / matt chrome



Kód / art.	C	L
157196	128	143
157197	160	175
157198	224	239

TOWADA

Broušený nikel / nickel brushed



Kód / art.	C	L
157193	128	143
157194	160	175
157195	224	239

KOVOVÉ ÚCHYTKY

METAL CABINET PULLS

MUTA

Hliník / aluminium

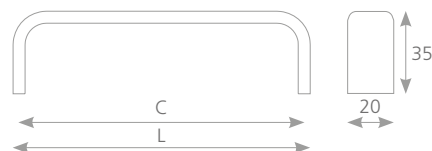

Kód / art.	C	L
36821	128	136
36822	160	168
36823	192	200
36824	224	232

Kód / art.	C	L
36825	320	328
36826	448	456
36827	544	552
36828	736	744

MUTA

Imitace nerezí / stainless steel imitation

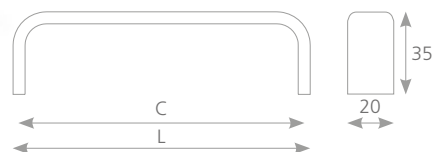

Kód / art.	C	L
36829	128	136
36830	160	168
36831	192	200
36832	224	232

Kód / art.	C	L
36833	320	328
36834	448	456
36835	544	552
36836	736	744

OGA

Satin chrom / matt chrome

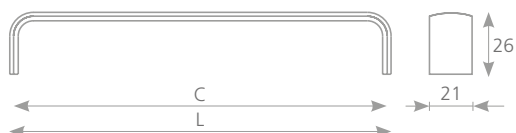

Kód / art.	C	L
157203	96	102
157204	128	134
157205	160	166
157206	192	198

KOVOVÉ ÚCHYTKY

METAL CABINET PULLS

OGA

Broušený nikel / nickel brushed



Kód / art.	C	L
157199	96	102
157200	128	134
157201	160	166
157202	192	198

STIRO

Chrom / polished chrome

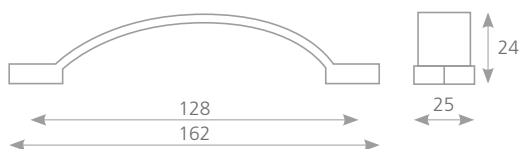

Kód / art.

210969

STIRO

Broušený nikel / nickel brushed

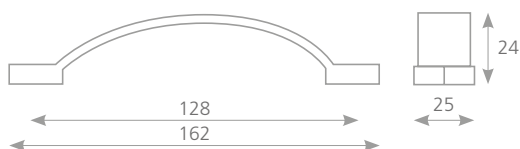

Kód / art.

210970

KOVOVÉ ÚCHYTKY

METAL CABINET PULLS

SCALA

Hliník / aluminium



Kód / art.	C	L
227249	160	179
227250	192	211
227251	224	243
227252	320	339
227252	448	467
227254	544	563
227254	640	659

SCALA

Imitace nerezí / stainless steel imitation



Kód / art.	C	L
227240	160	179
227242	192	211
227243	224	243
227244	320	339
227245	448	467
227246	544	563
227247	640	659

KOVOVÉ ÚCHYTKY

METAL CABINET PULLS

MARCA

Imitace nerezí / stainless steel imitation



Kód / art.	C	L
225008	160	197
225009	192	229
225010	224	261
225011	320	357
225012	448	485

HARUNA

Broušený nikl / nickel brushed

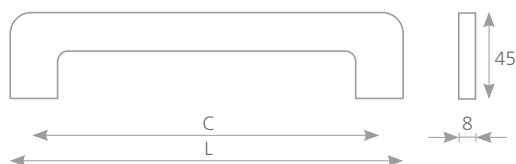

Kód / art.	C	L
157225	128	147
157226	160	179
157227	224	243

KOVOVÉ ÚCHYTKY

METAL CABINET PULLS

ASAMA

Satin chrom / matt chrome

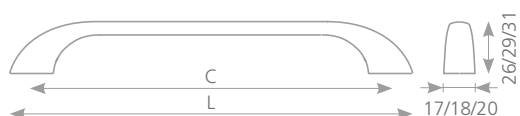

Kód / art.	C	L
157231	160	204
157232	192	245
157233	288	366

ASAMA

Satin nikl / matt nickel

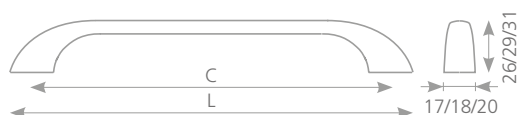

Kód / art.	C	L
157228	160	204
157229	192	245
157230	288	366

ASAMA

Broušený nikl / nickel brushed

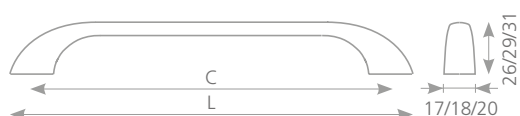

Kód / art.	C	L
157234	160	204
157235	192	245
157236	288	366

KOVOVÉ ÚCHYTKY

METAL CABINET PULLS

ROMINA

Chrom / polished chrome

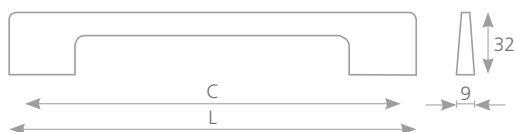

Kód / art.	C	L
202984	192	212
202986	256	276
202987	320	340
202988	448	468

ROMINA

Imitace nerez / stainless steel imitation

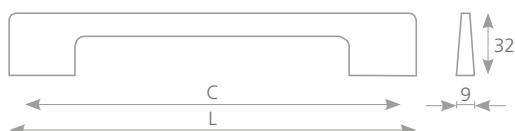

Kód / art.	C	L
202989	192	212
202990	256	276
202991	320	340
202992	448	468

ISA

Matný bílý chrom / chrom
Matt white chrome / polished chrome



Kód / art.	C	L
37321	96	108
37322	128	140

KOVOVÉ ÚCHYTKY

METAL CABINET PULLS

AIRA

Matný bílý chrom / chrom
Matt white chrome / polished chrome



Kód / art.	C	L	V	H
37301	96	105	28	17
37302	128	137	28	17
37311	128	140	32	24
37312	160	172	32	24
37313	320	332	32	24

DARA

Satin chrom / chrom
Matt chrome / polished chrome

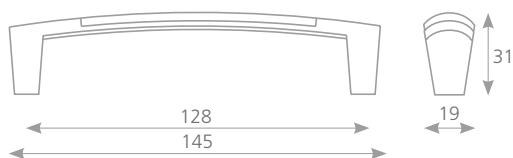

Kód / art.

37751

MUSINA

Satin chrom / chrom
Matt chrome / polished chrome

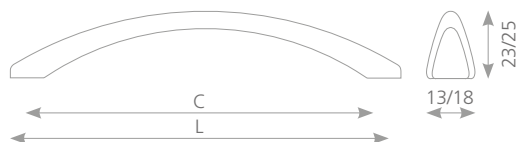

Kód / art.	C	L
37101	64	82
37102	96	123

KOVOVÉ ÚCHYTKY

METAL CABINET PULLS

SITA

Satin chrom / chrom

Matt chrome / polished chrome



Kód / art.

37131

EBINA

Satin chrom / chrom

Matt chrome / polished chrome

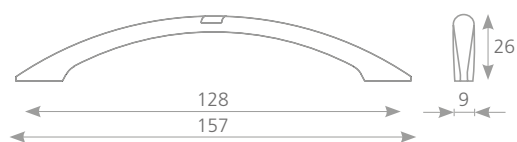

Kód / art.

37091

ENOKA

Satin chrom / chrom

Matt chrome / polished chrome

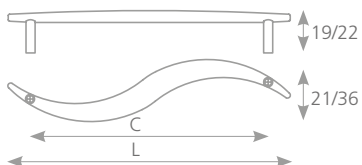

Kód / art.

C

L

37121

64

83

37122

96

124

KOVOVÉ ÚCHYTKY

METAL CABINET PULLS

RUSA

Satin chrom / chrom

Matt chrome / polished chrome

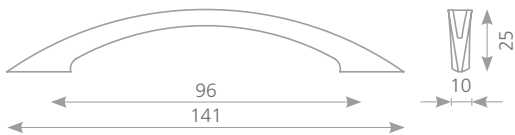

Kód / art.

37111

KAMA

Chrom / polished chrome

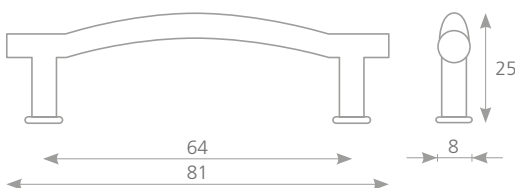

Kód / art.

37164

KOVOVÉ ÚCHYTKY

METAL CABINET PULLS

HRAZDA

Satin nikel / matt nickel

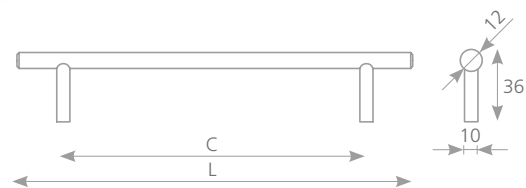

Kód / art.	C	L
35941	96	136
35921	128	168
35661	160	200
36731	192	232
35931	224	264
36741	288	328
35651	320	360

Kód / art.	C	L
35951	448	488
35641	544	584
36751	672	712
35961	736	776
36761	768	808
36771	832	872
36781	960	1000

HRAZDA

Satin chrom / matt chrome

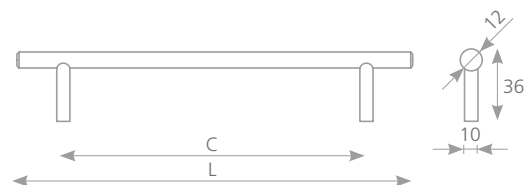

Kód / art.	C	L
35942	96	136
35922	128	168
35662	160	200
36732	192	232
35932	224	264
36742	288	328
35652	320	360

Kód / art.	C	L
35952	448	488
35642	544	584
36752	672	712
35962	736	776
36762	768	808
36772	832	872
36782	960	1000

KOVOVÉ ÚCHYTKY

METAL CABINET PULLS

HRAZDA

Chrom / polished chrome

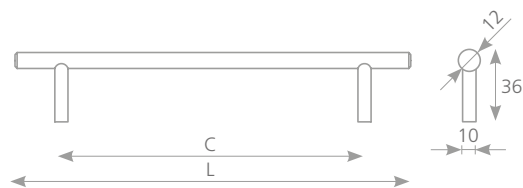

Kód / art.	C	L
35943	96	136
35923	128	168
35663	160	200
36733	192	232
35933	224	264
36743	288	328
35653	320	360

Kód / art.	C	L
35953	448	488
35643	544	584
36753	672	712
35963	736	776
36763	768	808
36773	832	872
36783	960	1000

HRAZDA

Broušený nikel / nickel brushed

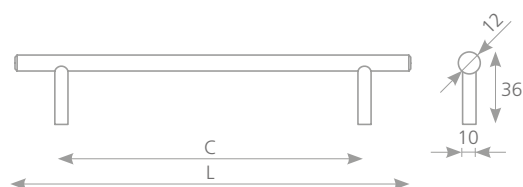

Kód / art.	C	L
35947	96	136
35927	128	168
35667	160	200
36737	192	232
35937	224	264
36747	288	328
35657	320	360

Kód / art.	C	L
35957	448	488
35647	544	584
36757	672	712
35967	736	776
36767	768	808
36777	832	872
36787	960	1000

KOVOVÉ ÚCHYTKY

METAL CABINET PULLS

HRAZDA

Hliník / aluminium

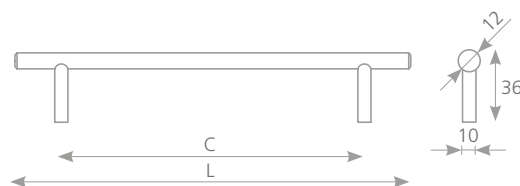

Kód / art.	C	L
202798	96	136
202799	128	168
202800	160	200
202801	192	232
202802	224	264
202803	288	328

Kód / art.	C	L
202804	320	360
202805	448	488
202806	544	584
202807	672	712
202808	736	776

HRAZDA

Dutá nerez, průměr 12
Hollow stainless steel, diameter 12

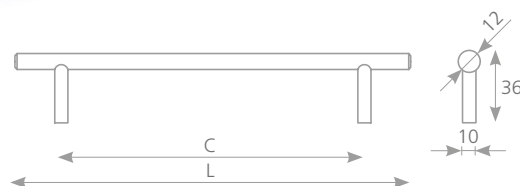

Kód / art.	C	L
10640	96	126
10641	128	170
10642	160	202
10643	192	234
10644	224	266
10645	288	330
10646	320	362
10647	384	426
10648	448	490

Kód / art.	C	L
10649	512	554
10650	576	618
10651	640	682
10652	672	714
10653	736	778
10654	768	810
10655	832	874
10656	896	938
10657	960	1002

KOVOVÉ ÚCHYTKY

METAL CABINET PULLS

PENKA

Broušený nikel / nickel brushed

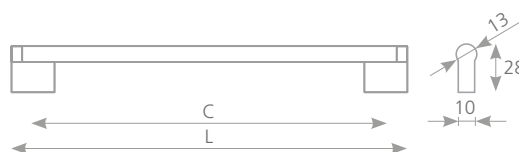

Kód / art.	C	L
157249	96	104
157250	128	136
157251	160	168
157252	192	200
157253	224	232

Kód / art.	C	L
157254	256	264
157255	320	328
157256	448	456
157257	560	568

PORINA

Chrom / polished chrome



Kód / art.	C	L
157258	96	162
157259	128	194
157260	160	226
157261	224	290
157262	256	322
157263	320	386
157264	480	546

KOVOVÉ ÚCHYTKY

METAL CABINET PULLS

MORINA

Matný bílý chrom / chrom
Matt white chrome / polished chrome

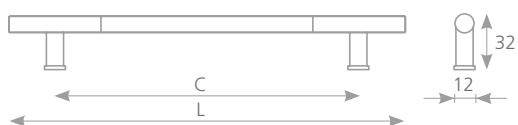

Kód / art.	C	L
37011	128	168
37012	160	200
157773	192	232
157774	256	296
37013	320	360
157775	384	424

RUMO

Matný bílý chrom / matt white chrome



Kód / art.	C	L
37021	128	176
37022	160	208

DALO

Satin chrom / matt chrome

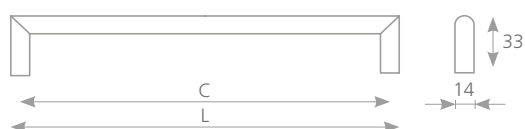

Kód / art.	C	L
36311	128	140
36312	160	174

KOVOVÉ ÚCHYTKY

METAL CABINET PULLS

RITTO

Hliník / aluminium



knopka RITTO (str. 129)
knob RITTO (pg. 129)



věšák RITTO (str. 262)
hook RITTO (pg. 262)



Kód / art.	C	L
UG020	128	148
UG030	160	180
UG040	192	212
UG050	256	276

Kód / art.	C	L
UG060	320	340
UG070	448	468
UG080	480	500
UG090	512	532

RITTO

Černá mat / zbroúšená hrana
Matt black / grinded edge

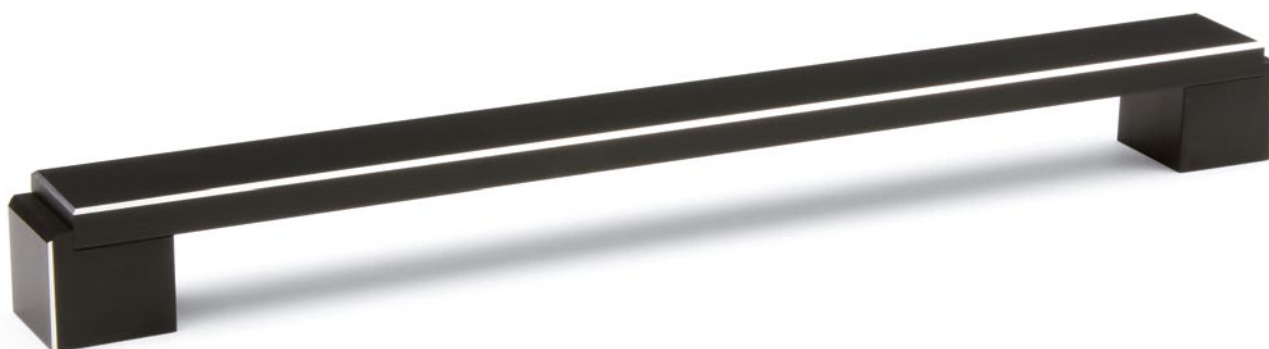

knopka RITTO (str. 130)
knob RITTO (pg. 130)



Kód / art.	C	L
UG023	128	148
UG033	160	180
UG043	192	212
UG053	256	276

Kód / art.	C	L
UG063	320	340
UG073	448	468
UG083	480	500
UG093	512	532

KOVOVÉ ÚCHYTKY

METAL CABINET PULLS

RITTO

Chrom lesk / polished chrome

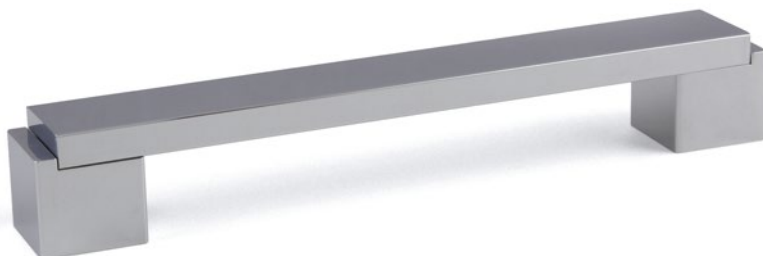

knopka RITTO (str. 129)
knop RITTO (pg. 129)

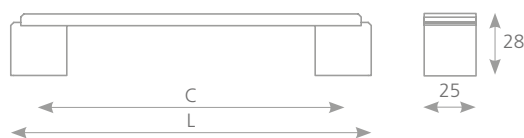

Kód / art.	C	L
UG021	128	148
UG031	160	180
UG041	192	212
UG051	256	276

Kód / art.	C	L
UG061	320	340
UG071	448	468
UG081	480	500
UG091	512	532

RITTO

Černá mat / zkosená hrana

Matt black / bevel edge

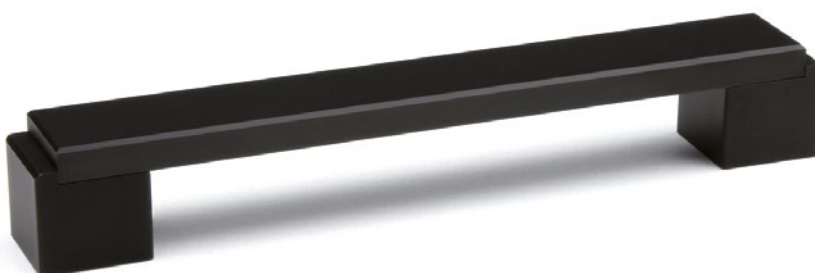

knopka RITTO (str. 129)
knob RITTO (pg. 129)

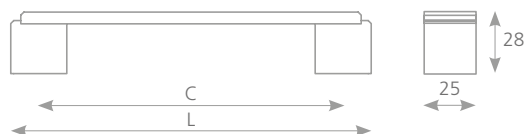

Kód / art.	C	L
UG022 •	128	148
UG032 •	160	180
UG042 •	192	212
UG052 •	256	276

Kód / art.	C	L
UG062 •	320	340
UG072 •	448	468
UG082 •	480	500
UG092 •	512	532

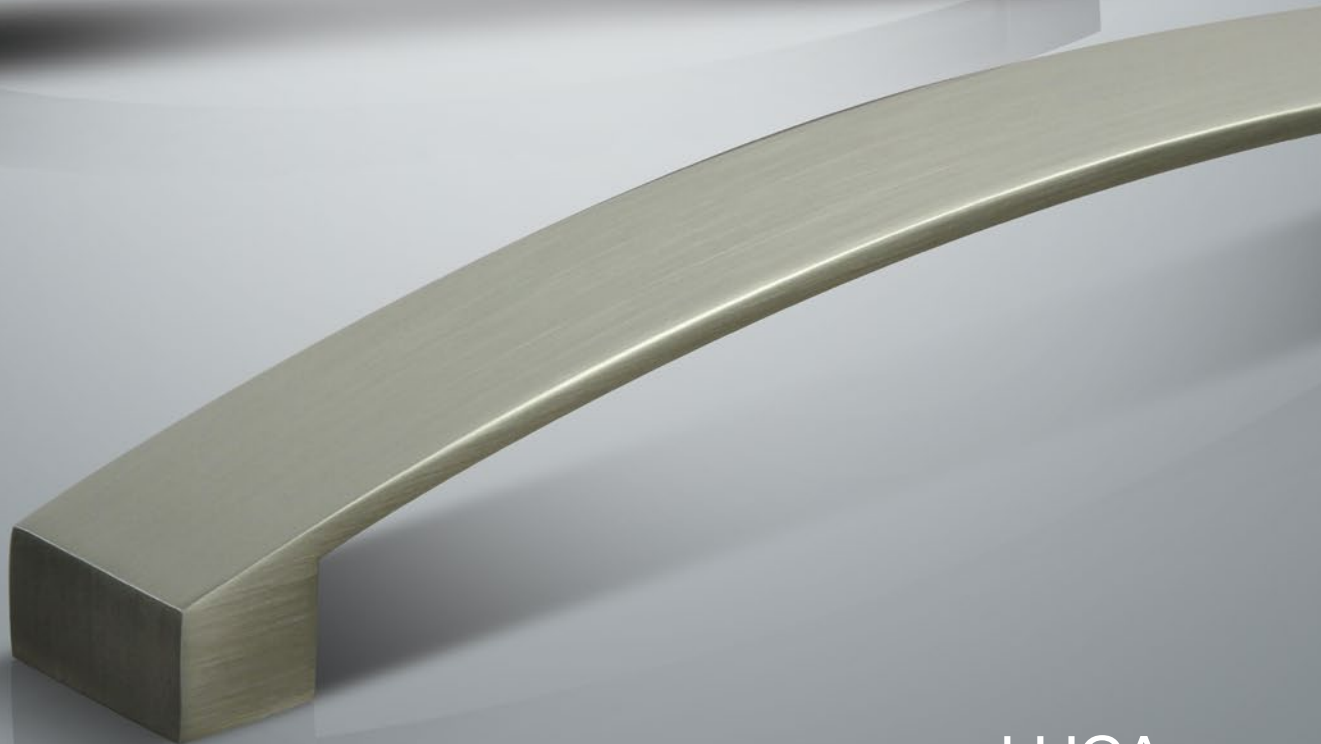

LUCA

Imitace nerezi

Stainless steel imitation

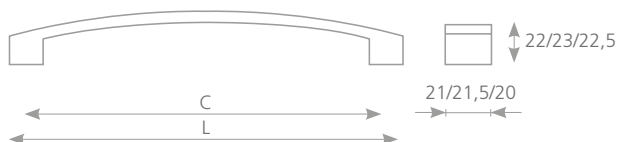

Kód / art.	C	L
224945	128	141
224946	160	172
224947	224	235
224948	256	267,5

KOVOVÉ ÚCHYTKY

METAL CABINET PULLS

LUCA

Satin chrom / matt chrome

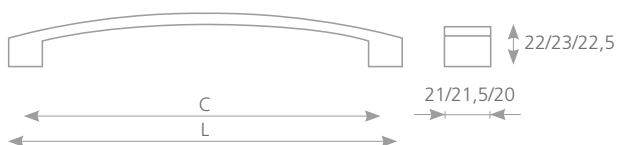

Kód / art.	C	L
224941	128	141
224942	160	172
224943	224	235
224944	256	267,5

MENUSA

Hliník / aluminium

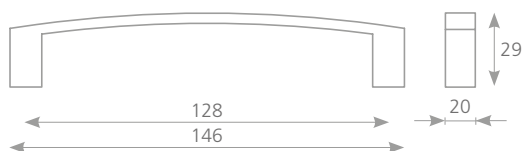

Kód / art.

35971

ULICA

Satin nikl / matt nickel

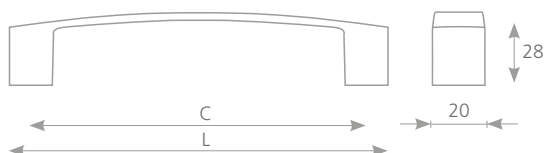

Kód / art.	C	L
227089	128	146
227090	160	178
227091	192	210
227092	256	274
227093	320	338
227094	416	434

KOVOVÉ ÚCHYTKY

METAL CABINET PULLS

ULICA

Satin chrom / matt chrome

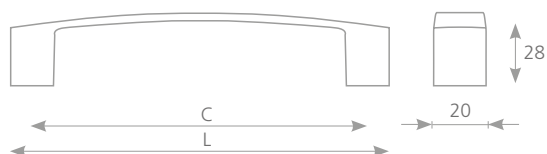

Kód / art.	C	L
227095	128	146
227096	160	178
227097	192	210
227098	256	274
227099	320	338
227100	416	434

RODOSO

Satin chrom / matt chrome

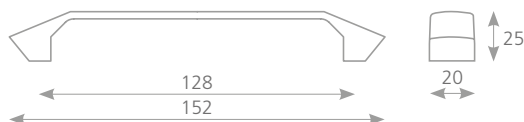

Kód / art.

37761

KAMINA

Stříbrná / silver



Kód / art.	C	L
77936	160	191
77937	256	287

KOVOVÉ ÚCHYTKY

METAL CABINET PULLS

KAMINA

Imitace nerezí / stainless steel imitation



Kód / art.	C	L
77939	160	191
77940	256	287

FORO

Stříbrná / silver

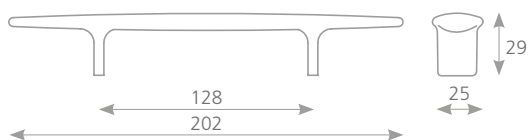

knopka FORO (str. 119)
knob FORO (pg. 119)

Kód / art.

77821

PAMIL

Satin chrom / matt chrome

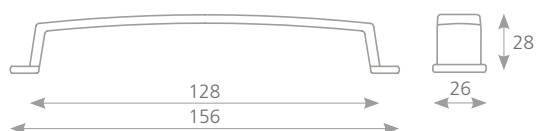

Kód / art.

35822

KOVOVÉ ÚCHYTKY

METAL CABINET PULLS

PAMIL

Broušený nikel / nickel brushed

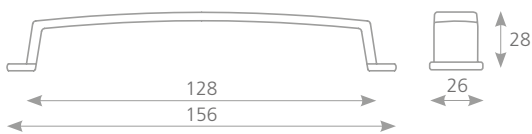

Kód / art.

35827

SELENA

Stříbrná / silver



Kód / art.

C

L

77942

160

216

77944

256

341

SELENA

Imitace nerez / stainless steel imitation



Kód / art.

C

L

77943

160

216

77945

256

341

KOVOVÉ ÚCHYTKY

METAL CABINET PULLS

ROTONDA

Bílá / white



Kód / art.

227258 •

ROTONDA

Imitace nerezí / stainless steel imitation



Kód / art.

227259 •

PIEGATA

Bílá / white

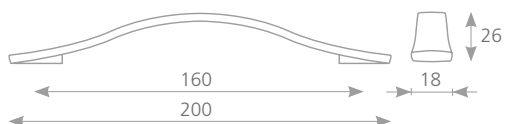

Kód / art.

227256 •



PIEGATA

Satin niki
Matt nickel

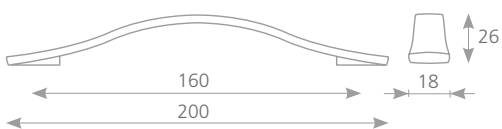

Kód / art.
227257 •

www.tulip-design.com

• Skladem od 7/2015 | Available from 7/2015

tulip

KOVOVÉ ÚCHYTKY

METAL CABINET PULLS

SEKOL

Antik English / antique English



knopka SEKOL (str. 136)
knob SEKOL (pg. 136)

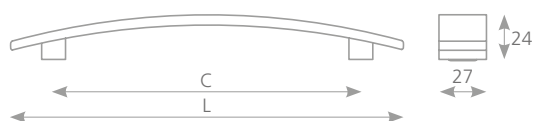

Kód / art.	C	L
157270	96	156
157271	128	188
157272	160	230

SEKOL

Chrom / polished chrome



knopka SEKOL (str. 136)
knob SEKOL (pg. 136)



Kód / art.	C	L
157276	96	156
157277	128	188
157278	160	230

MITIDA

Satin chrom / matt chrome

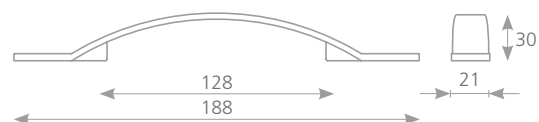

Kód / art.
37731

KOVOVÉ ÚCHYTKY

METAL CABINET PULLS

MARIBA

Imitace nerezí mat / stainless steel imitation matt

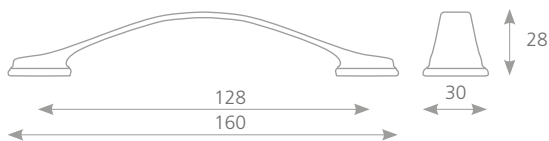

Kód / art.

267104 •

MARIBA

Imitace nerezí tmavá broušená / stainless steel dark brushed

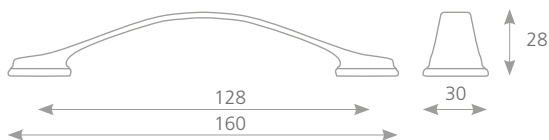

Kód / art.

267105 •

MALADA

Satin chrom / matt chrome

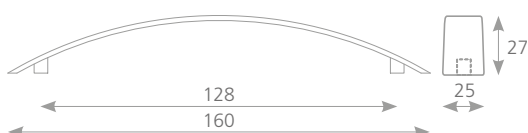

Kód / art.

35832

KOVOVÉ ÚCHYTKY

METAL CABINET PULLS

MALADA

Broušený nikel / nickel brushed

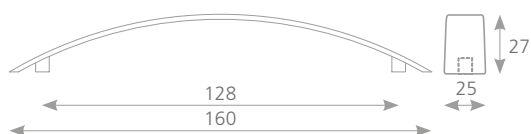

Kód / art.

35837

FUKOL

Satin chrom / matt chrome

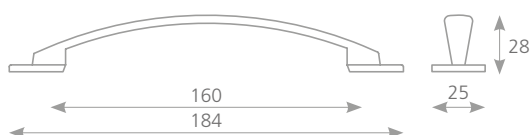

Kód / art.

35432

KETA

Satin nikel / matt nickel



Kód / art.

35131

KOVOVÉ ÚCHYTKY

METAL CABINET PULLS

LUDA

Mosaz / brass

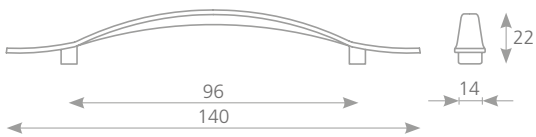

Kód / art.

07603

LUDA

Chrom / polished chrome

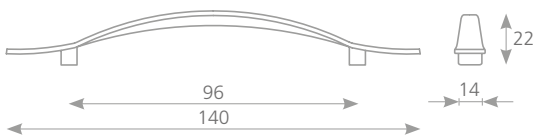

Kód / art.

07604

LUDA

Satin nikl / matt nickel

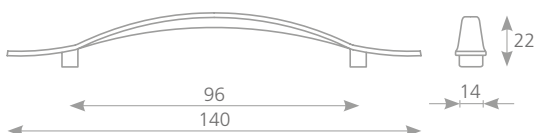

Kód / art.

07606

KOVOVÉ ÚCHYTKY

METAL CABINET PULLS

UNESA

Satin chrom / matt chrome



Kód / art.	C	L
157529	96	152
35412	128	184
157532	160	216

UNESA

Broušený nikel / nickel brushed



Kód / art.	C	L
157530	96	152
157531	128	184
157533	160	216

KOVOVÉ ÚCHYTKY

METAL CABINET PULLS

ILUNA

Satin nikel / matt nickel

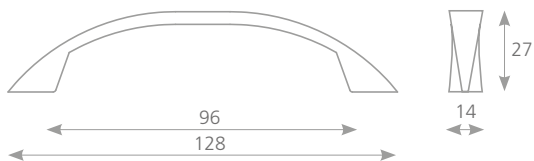

Kód / art.

35301

ILUNA

Satin chrom / matt chrome

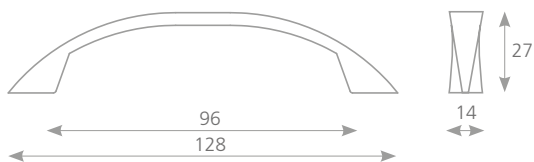

Kód / art.

157527

ILUNA

Broušený nikel / nickel brushed

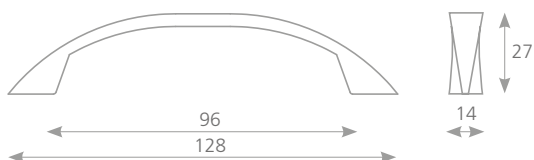

Kód / art.

157528

KOVOVÉ ÚCHYTKY

METAL CABINET PULLS

PENETA

Satin nikl / matt nickel

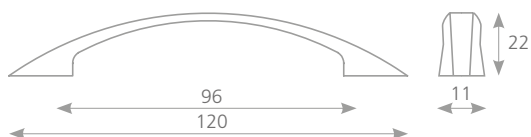

Kód / art.

08906

PENETA

Chrom / polished chrome

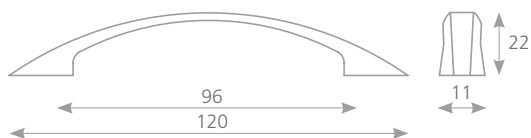

Kód / art.

08904

IBIKA

Satin nikl / matt nickel

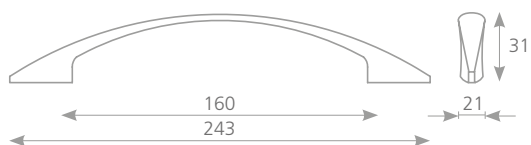

Kód / art.

35701

KOVOVÉ ÚCHYTKY

METAL CABINET PULLS

PALIN

Satin nikel / matt nickel

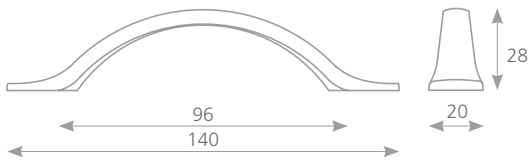

Kód / art.

35561

PALIN

Chrom / polished chrome

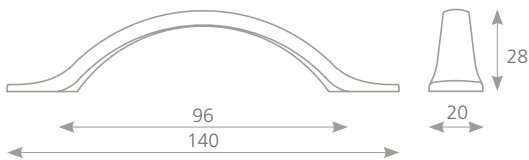

Kód / art.

35563

PALIN

Mosaz / brass

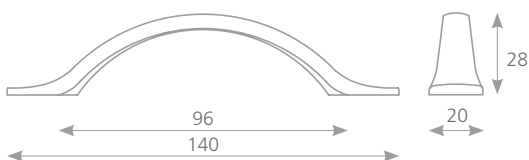

Kód / art.

35564

KOVOVÉ ÚCHYTKY

METAL CABINET PULLS

NOMINA

Satin nikl / matt nickel

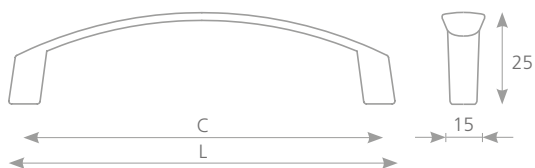

Kód / art.	C	L
157535	96	108
35231	128	140

NOMINA

Satin chrom / matt chrome

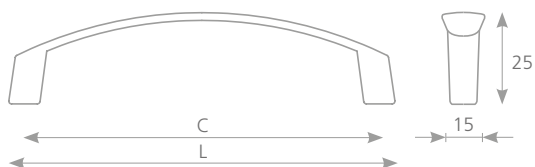

Kód / art.	C	L
157534	96	108
35232	128	140

NOMINA

Chrom / polished chrome

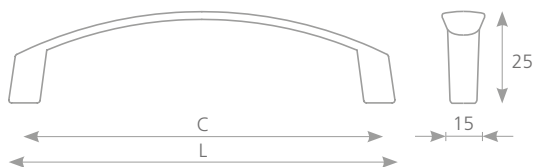

Kód / art.	C	L
157536	96	108
35233	128	140

KOVOVÉ ÚCHYTKY

METAL CABINET PULLS

GENEDA

Satin chrom / matt chrome

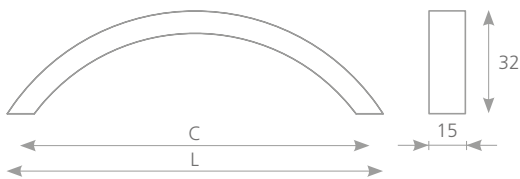

Kód / art.	C	L
35112	96	106
157539	128	140

GENEDA

Chrom / polished chrome

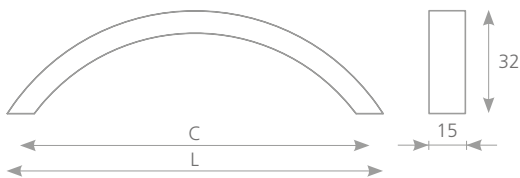

Kód / art.	C	L
157538	96	106
157541	128	140

GENEDA

Broušený nikel / nickel brushed

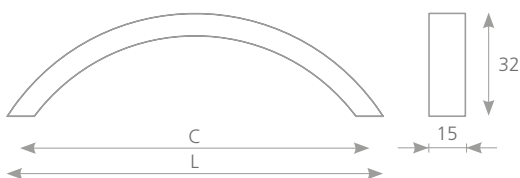

Kód / art.	C	L
157537	96	106
157540	128	140

KOVOVÉ ÚCHYTKY

METAL CABINET PULLS

SAKITA

Satin nikel / matt nickel

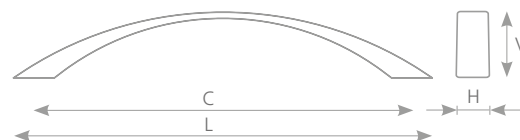

Kód / art.	C	L	V	H
157551	64	160	19	7
157554	96	192	25	8
157721	128	224	31	8

Kód / art.	C	L	V	H
157724	160	186	32	8
157702	192	218	34	8
157705	224	253	36	8

SAKITA

Chrom / polished chrome

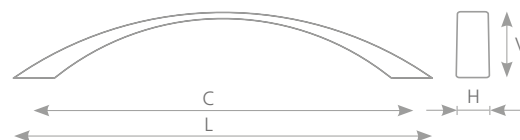

Kód / art.	C	L	V	H
157552	64	160	19	7
157555	96	192	25	8
157722	128	224	31	8

Kód / art.	C	L	V	H
157700	160	186	32	8
157703	192	218	34	8
157706	224	253	36	8

SAKITA

Broušený nikel / nickel brushed

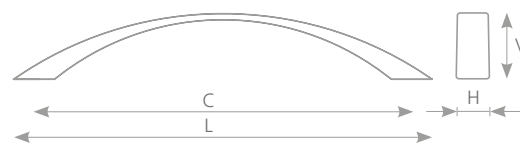

Kód / art.	C	L	V	H
157553	64	160	19	7
157556	96	192	25	8
157723	128	224	31	8

Kód / art.	C	L	V	H
157701	160	186	32	8
157704	192	218	34	8
157707	224	253	36	8

KOVOVÉ ÚCHYTKY

METAL CABINET PULLS

PELENA

Satin chrom / matt chrome

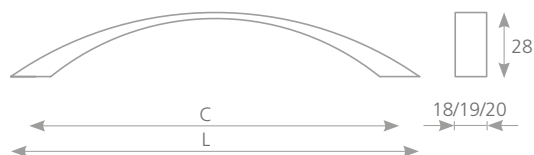

Kód / art.	C	L
157832	96	106
157833	128	140
157834	160	174

Kód / art.	C	L
37742	192	228
157835	224	257

PELENA

Broušený nikl / nickel brushed

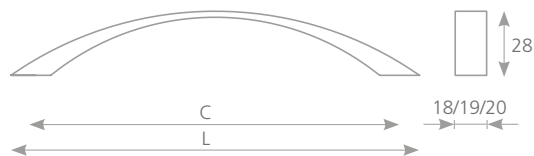

Kód / art.	C	L
157824	96	106
157825	128	140
157826	160	174

Kód / art.	C	L
37741	192	228
157827	224	257

PIOMBINA

Satin nikl / matt nickel

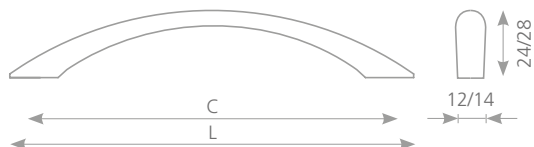

Kód / art.	C	L
35251	96	127
35241	128	164

KOVOVÉ ÚCHYTKY

METAL CABINET PULLS

PIOMBINA

Satin chrom / matt chrome

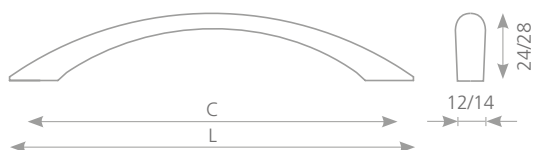

Kód / art.	C	L
35252	96	127
35242	128	164

PIOMBINA

Chrom / polished chrome

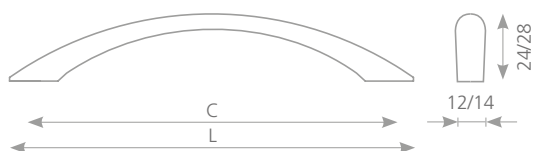

Kód / art.	C	L
35253	96	127
35243	128	164

PIOMBINA

Mosaz / brass

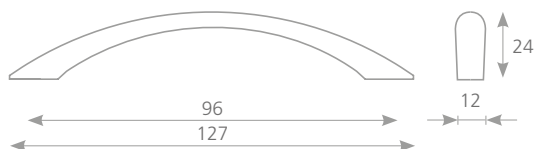

Kód / art.
35254

KOVOVÉ ÚCHYTKY

METAL CABINET PULLS

PIOMBINA

Černá / black

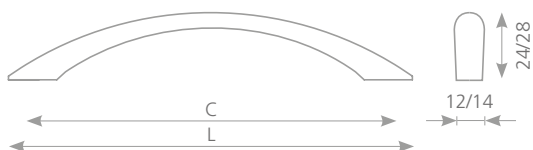

Kód / art.	C	L
35255	96	127
35245	128	164

PIOMBINA

Černý nikl / black nickel

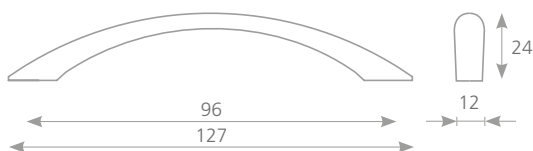

Kód / art.
35258

PIOMBINA

Broušený nikl / nickel brushed

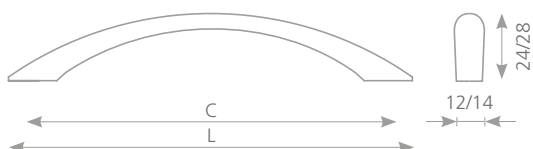

Kód / art.	C	L
157520	96	127
157521	128	164

KOVOVÉ ÚCHYTKY

METAL CABINET PULLS

PIOMBINA

Staroměď / old copper

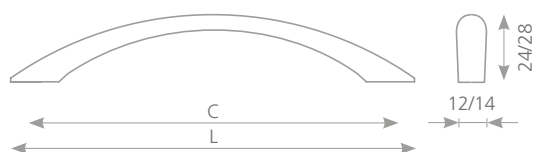

Kód / art.	C	L
226980	96	127
226981	128	164

PIOMBINA

Starocín / old pewter

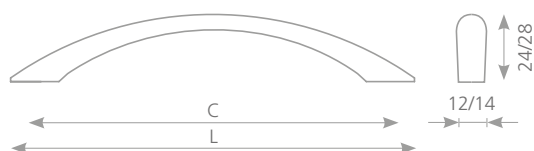

Kód / art.	C	L
226979	96	127
226983	128	164

ANITA

Satin nikel / matt nickel

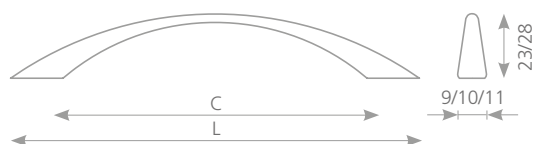

Kód / art.	C	L
35071	64	81
35081	96	115
35091	128	164

KOVOVÉ ÚCHYTKY

METAL CABINET PULLS

ANITA

Satin chrom / matt chrome



Kód / art.	C	L
35072	64	81
35082	96	115
35092	128	164

ANITA

Chrom / polished chrome

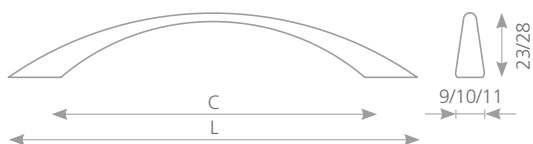

Kód / art.	C	L
35073	64	81
35083	96	115
35093	128	164

ANITA

Černá / black



Kód / art.	C	L
35075	64	81
35085	96	115
35095	128	164

KOVOVÉ ÚCHYTKY

METAL CABINET PULLS

ANITA

Bílá / white

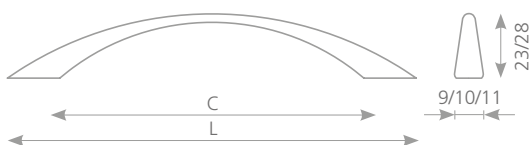

Kód / art.	C	L
35079	64	81
35089	96	115

ANITA

Černý nikel / black nickel

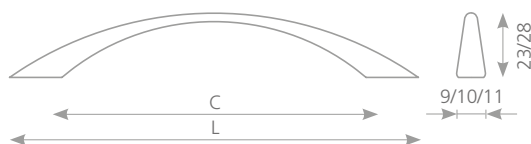

Kód / art.	C	L
35088	96	115
35098	128	164

ANITA

Broušený nikel / nickel brushed

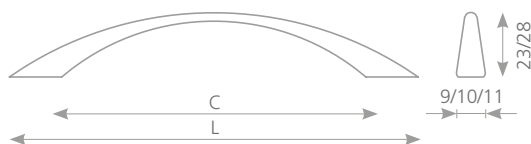

Kód / art.	C	L
157524	64	81
157525	96	115
157526	128	164

KOVOVÉ ÚCHYTKY

METAL CABINET PULLS

ANITA

Starocín / old pewter

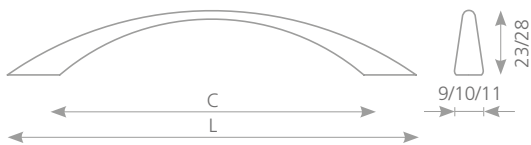

Kód / art.	C	L
226984	96	115
226988	128	164

ANITA

Staroměď / old copper



Kód / art.	C	L
226985	96	115
226987	128	164

ANITA

Mosaz / brass

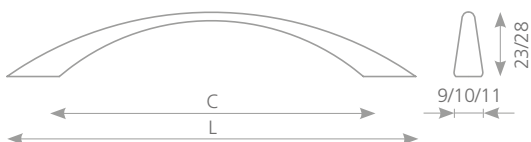

Kód / art.	C	L
35074	64	81
35084	96	115
35094	128	164

KOVOVÉ ÚCHYTKY

METAL CABINET PULLS

OLIFO

Satin nikl / matt nickel



Kód / art.

35101

TIMINA

Chrom / polished chrome



Kód / art.

C

L

157709

96

123

157712

128

157

157715

160

190

UROSO

Satin nikl / matt nickel



Kód / art.

C

L

35631

96

112

35141

128

146

KOVOVÉ ÚCHYTKY

METAL CABINET PULLS

UROSO

Satin chrom / matt chrome



Kód / art.	C	L
35632	96	112
35142	128	146

UROSO

Chrom / polished chrome



Kód / art.	C	L
35633	96	112
35143	128	146

PRIMA

Satin nikl / matt nickel

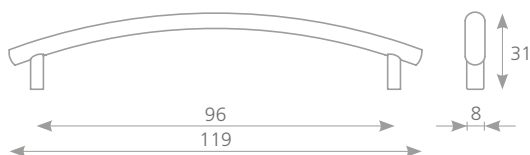

Kód / art.
35051

KOVOVÉ ÚCHYTKY

METAL CABINET PULLS

PRIMA

Satin chrom / matt chrome

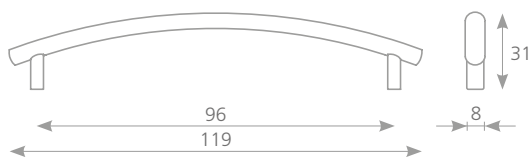

Kód / art.

35052

PRIMA

Chrom / polished chrome

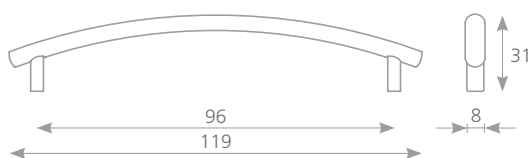

Kód / art.

35053

LOMINA

Satin nikl / matt nickel

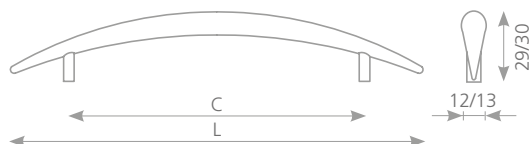

Kód / art.

C

L

35191

96

126

35061

128

184

KOVOVÉ ÚCHYTKY

METAL CABINET PULLS

LOMINA

Satin chrom / matt chrome

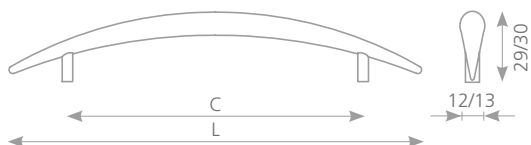

Kód / art.	C	L
35192	96	126
35062	128	184

BESINA

Satin nikl / matt nickel

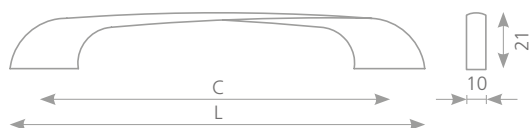

Kód / art.	C	L
35471	96	121
35481	128	157
35491	160	190

UMORA

Satin nikl / matt nickel

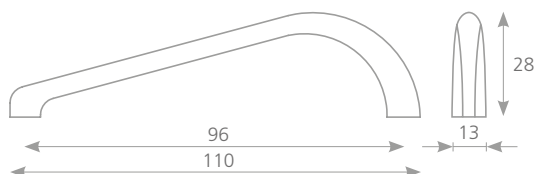

Kód / art.
35031

KOVOVÉ ÚCHYTKY

METAL CABINET PULLS

HALENA

Satin nikl / matt nickel

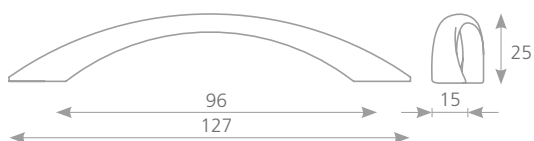

Kód / art.

35291

HALENA

Satin chrom / matt chrome

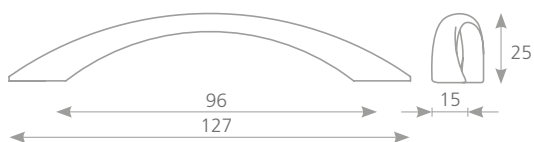

Kód / art.

35292

HALENA

Chrom / polished chrome

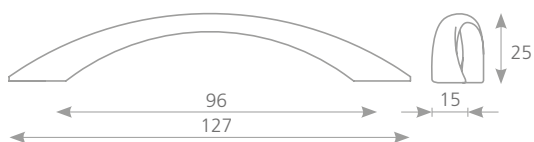

Kód / art.

35293

KOVOVÉ ÚCHYTKY

METAL CABINET PULLS

CEMUNA

Satin nikl / matt nickel



Kód / art.

35681

RESINA

Satin nikl / matt nickel

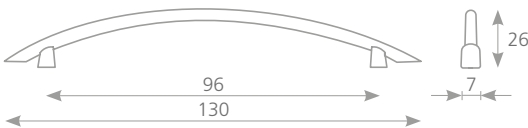

Kód / art.

08004

FIONA

Satin nikl / matt nickel

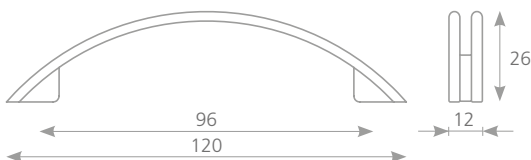

Kód / art.

35041

KOVOVÉ ÚCHYTKY

METAL CABINET PULLS

FIONA

Satin chrom / matt chrome

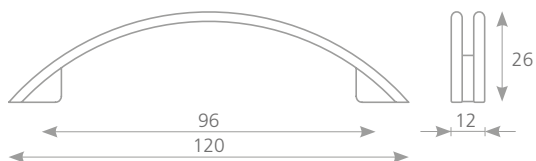

Kód / art.

35042

FIONA

Chrom / polished chrome

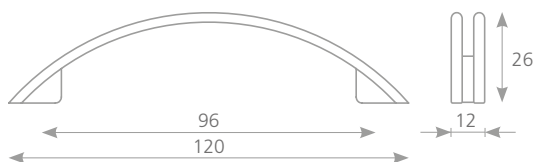

Kód / art.

35043

FIONA

Mosaz / brass

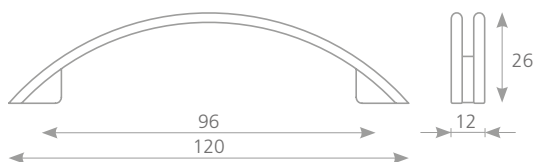

Kód / art.

35044

KOVOVÉ ÚCHYTKY

METAL CABINET PULLS

BETA

Satin nikl / matt nickel

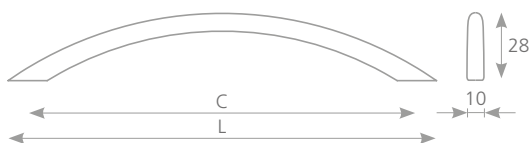

Kód / art.	C	L
35011	96	110
35021	128	160

BETA

Satin chrom / matt chrome

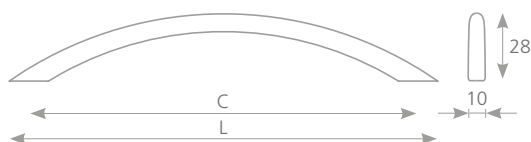

Kód / art.	C	L
35012	96	110
35022	128	160

BETA

Chrom / polished chrome

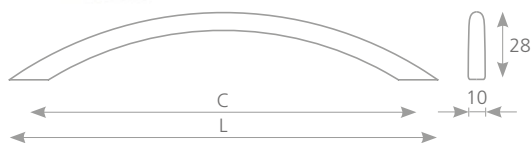

Kód / art.	C	L
35013	96	110
35023	128	160

KOVOVÉ ÚCHYTKY

METAL CABINET PULLS

BETA

Mosaz / brass

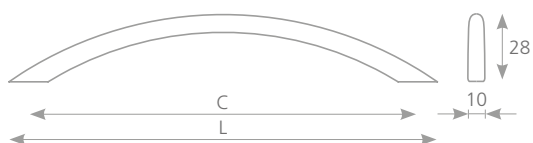

Kód / art.	C	L
35014	96	110
35024	128	160

BETA

Černá matná / matt black

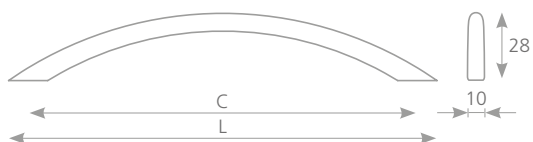

Kód / art.	C	L
35015	96	110
35025	128	160

BETA

Bílá / white

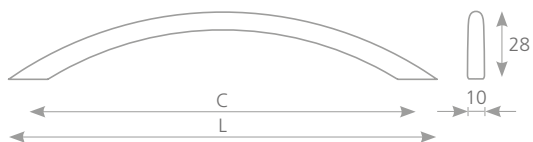

Kód / art.	C	L
35019	96	110
157522	128	160

KOVOVÉ ÚCHYTKY

METAL CABINET PULLS

BETA

Broušený nikel / nickel brushed

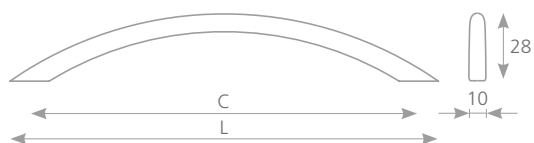

Kód / art.	C	L
35017	96	110
157523	128	160

IDA

Satin nikel / matt nickel

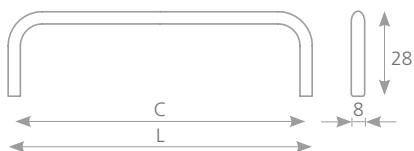

Kód / art.	C	L
35341	96	104
157544	128	136
231423	160	168

IDA

Chrom / polished chrome

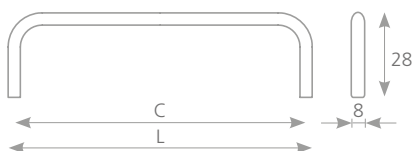

Kód / art.	C	L
157542	96	104
157545	128	136
231424	160	168

KOVOVÉ ÚCHYTKY

METAL CABINET PULLS

IDA

Broušený nikel / nickel brushed

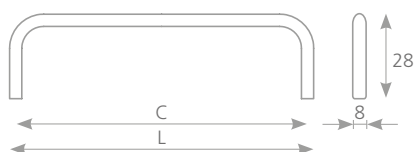

Kód / art.	C	L
157543	96	104
157546	128	136
231422	160	168

RUONA

Satin nikel / matt nickel

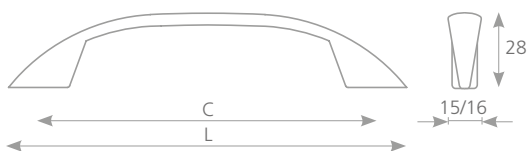

Kód / art.	C	L
35451	96	132
35461	128	164

RUONA

Satin chrom / matt chrome

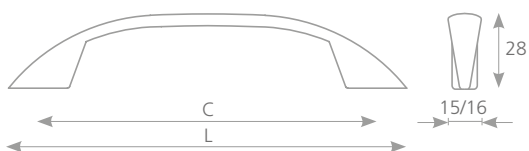

Kód / art.	C	L
35452	96	132
35462	128	164

KOVOVÉ ÚCHYTKY

METAL CABINET PULLS

RUONA

Chrom / polished chrome

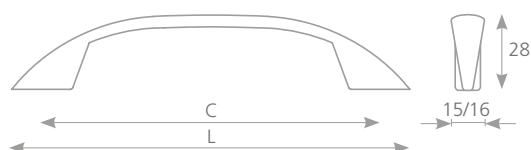

Kód / art.	C	L
35453	96	132
35463	128	164

RUONA

Mosaz / brass

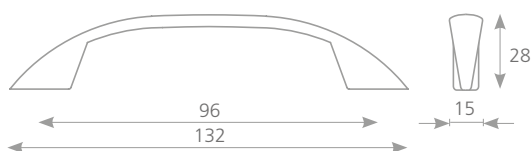

Kód / art.

35454

RUONA

Černá / black

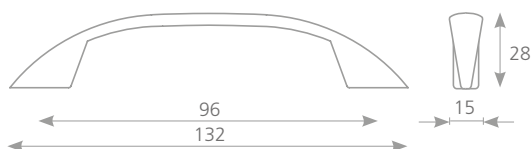

Kód / art.

35455

KOVOVÉ ÚCHYTKY

METAL CABINET PULLS

KEWINA

Satin nikl / matt nickel



Kód / art.	C	L
35161	96	124
35151	128	156

KEWINA

Satin chrom / matt chrome



Kód / art.	C	L
35162	96	124
35152	128	156

KEWINA

Chrom / polished chrome



Kód / art.	C	L
35163	96	124
35153	128	156

KOVOVÉ ÚCHYTKY

METAL CABINET PULLS

TORINO

Stříbrná / silver



Kód / art.	C	L
77920	96	116
77921	320	328

JAKOTO

Matný bílý chrom / matt white chrome

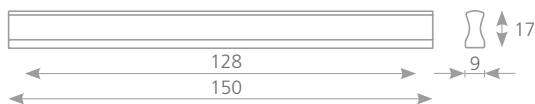

Kód / art.

37051

JAKOTO

Hliník / aluminium

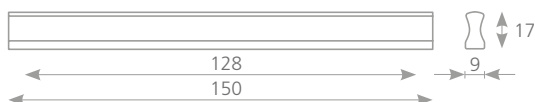

Kód / art.

37053

KOVOVÉ ÚCHYTKY

METAL CABINET PULLS

LIKANO

Hliník / aluminium

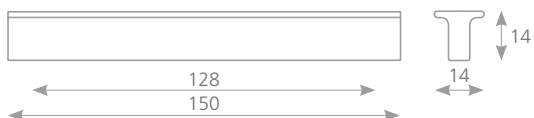
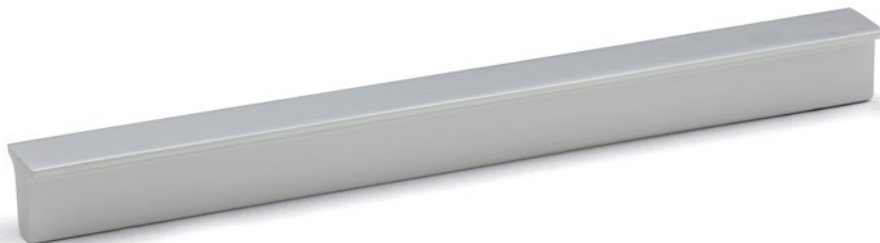

Kód / art.

36332

WAKANO

Hliník / aluminium

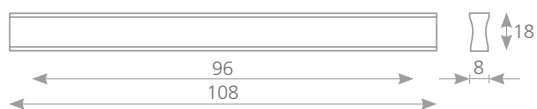

Kód / art.

36333

TALOMA

Hliník / aluminium

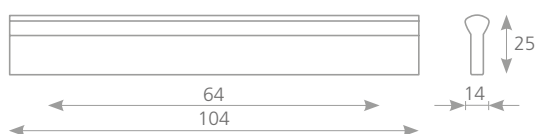

Kód / art.

37004

KOVOVÉ ÚCHYTKY

METAL CABINET PULLS

HYTECH

Hliník / aluminium

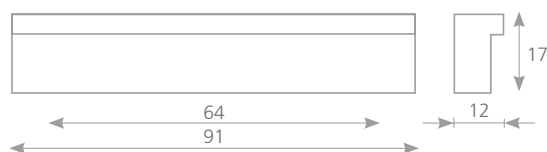

Kód / art.

190523

ZUZANA

Hliník / aluminium



Kód / art.

C

L

35900

32

44

35898

128

140

35899

360

372

PETARO

Hliník / aluminium

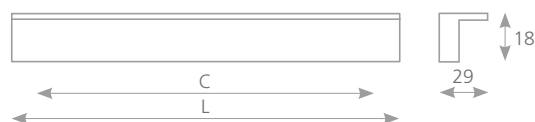

Kód / art.

C

L

157518

32

44

157519

96

108

36320

128

140

36321

160

172

Kód / art.

C

L

36322

224

236

36323

360

372

36324

488

500

KOVOVÉ ÚCHYTKY

METAL CABINET PULLS

ASUDA

Matný bílý chrom / matt white chrome

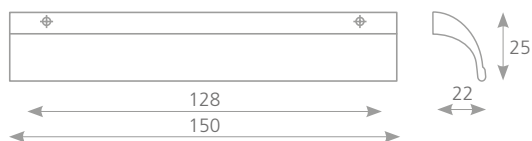

Kód / art.

37221

VOLENA

Satin chrom / matt chrome

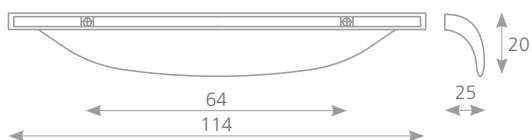

Kód / art.

37241

GREENDA

Imitace nerez / stainless steel imitation

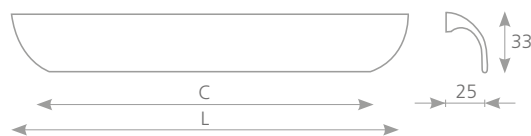

Kód / art.

C

L

Kód / art.

C

L

206141

64

114

206142

128

178

206144

192

242

206145

224

274

206146

320

370

KOVOVÉ ÚCHYTKY

METAL CABINET PULLS

MERITA

Stříbrná / silver



Kód / art.	C	L
77946	160	178
77948	256	338

MERITA

Imitace nerez / stainless steel imitation



Kód / art.	C	L
77947	160	178
77949	256	338

ISOLA

Chrom / polished chrome

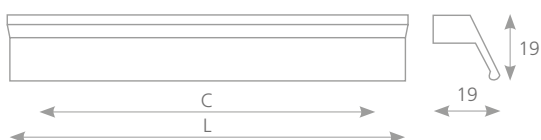

Kód / art.	C	L
227293	96	116
227294	160	180
227295	224	244
227296	320	340

KOVOVÉ ÚCHYTKY

METAL CABINET PULLS

ISOLA

Imitace nerez / stainless steel imitation

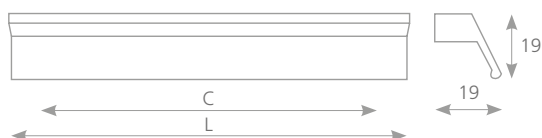

Kód / art.	C	L
227297	96	116
227298	160	180
227299	224	244
227300	320	340

ISOLA

Hliník / aluminium

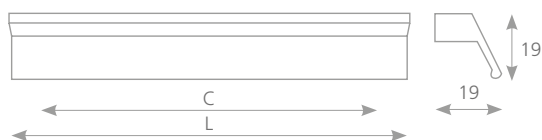

Kód / art.	C	L
227301	96	116
227302	160	180
227303	224	244
227304	320	340

PATRIC

Stříbrná / silver

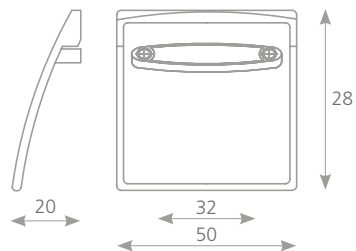

Kód / art.
77923

KOVOVÉ ÚCHYTKY

METAL CABINET PULLS

PATRIC

Stříbrná / silver

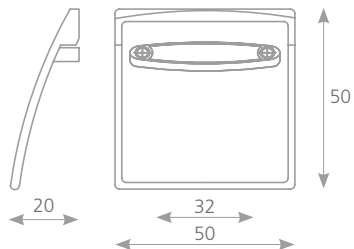

Kód / art.

77924

ZITO

Stříbrná / silver

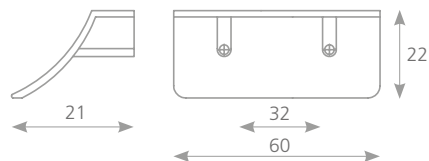

Kód / art.

77925

SEMA

Stříbrná / silver

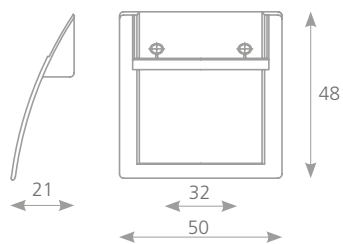

Kód / art.

77915

KOVOVÉ ÚCHYTKY

METAL CABINET PULLS

KETINA

Satin chrom / matt chrome

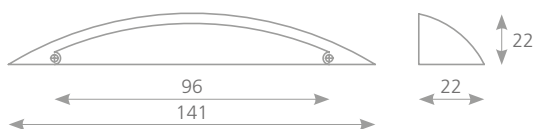

Kód / art.

35872

LOKUTA

Satin chrom / matt chrome

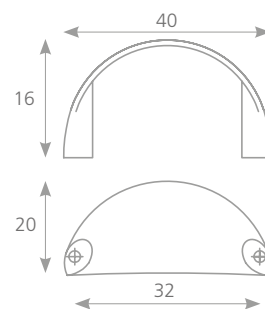

Kód / art.

37172

LOKUTA

Satin nikl / matt nickel

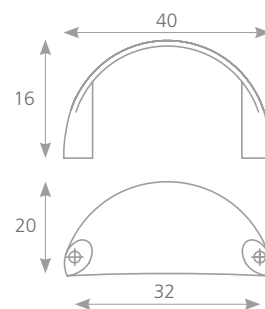

Kód / art.

07756

KOVOVÉ ÚCHYTKY

METAL CABINET PULLS

KVADRA

Chrom / polished chrome

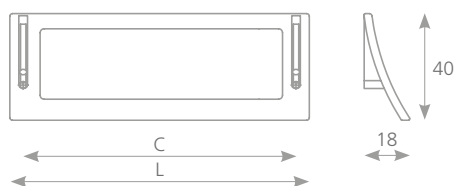

Kód / art.	C	L
77962	32	48
77960	160	175
77964	320	335

KVADRA

Broušený nikl / nickel brushed

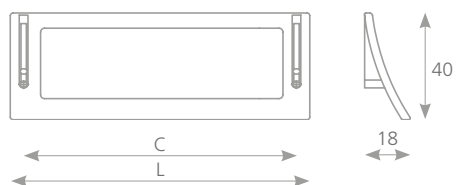

Kód / art.	C	L
77963	32	48
77961	160	175

BELUGA

Satin chrom / matt chrome



knopka BELUGA (str. 118)
knob BELUGA (pg. 118)

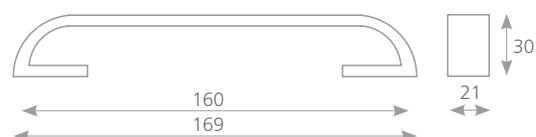

Kód / art.
42052

KOVOVÉ ÚCHYTKY

METAL CABINET PULLS

BELUGA

Imitace nerezí / stainless steel imitation



knopka BELUGA (str. 124)
knob BELUGA (pg. 124)

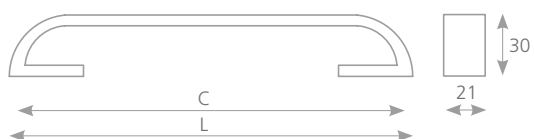

Kód / art.	C	L
42051	128	137
42053	160	169
157569	192	200
42055	224	233

BELUGA

Oxidovaná ocel / pewter

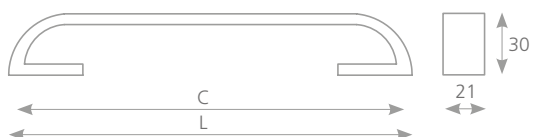

Kód / art.	C	L
157565	128	137
157566	160	169

BELUGA

Oxidovaná ocel tmavá / matt old steel

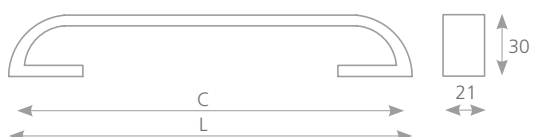

Kód / art.	C	L
157567	128	137
157568	160	169

KOVOVÉ ÚCHYTKY

METAL CABINET PULLS

PADOVA

Imitace nerezí / stainless steel imitation

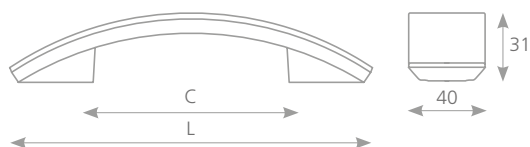

Kód / art.	C	L
157617	96	162
157618	224	290
157619	256	320

CORDOBA

Imitace nerezí / stainless steel imitation



Kód / art.	C	L
157609	160	257
157610	192	289
157611	192	321

RECIFE

Chrom / polished chrome

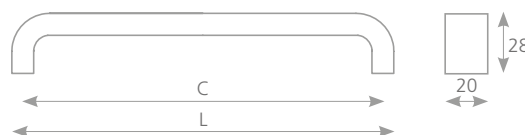
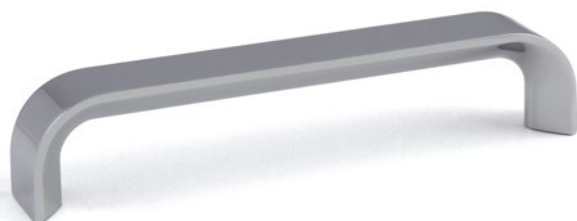

Kód / art.	C	L
157632	128	137
157633	192	201
157634	224	233

Kód / art.	C	L
157635	256	265
157636	320	329
157637	448	457

KOVOVÉ ÚCHYTKY

METAL CABINET PULLS

RECIFE

Imitace nerezzi / stainless steel imitation

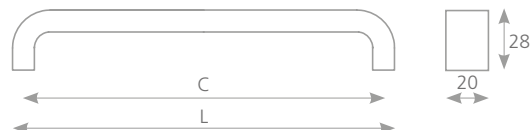

Kód / art.	C	L
157638	128	137
157639	192	201
157640	224	233

Kód / art.	C	L
157641	256	265
157642	320	329
157643	448	457

SANTIAGO

Imitace nerezzi / stainless steel imitation

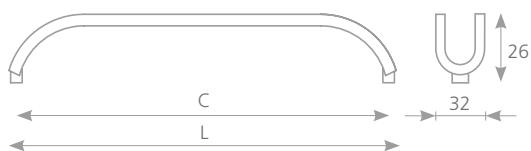

Kód / art.	C	L
157658	64	72
157659	192	201

ELIPSE

Imitace nerezzi / stainless steel imitation

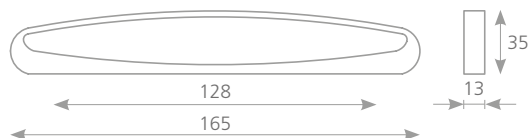

Kód / art.
42002

KOVOVÉ ÚCHYTKY

METAL CABINET PULLS

ARGUS

Satin chrom / matt chrome

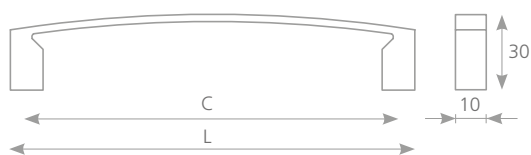

Kód / art.	C	L
42069	96	110
42071	128	140
42073	160	173

ARGUS

Imitace nerezi / stainless steel imitation

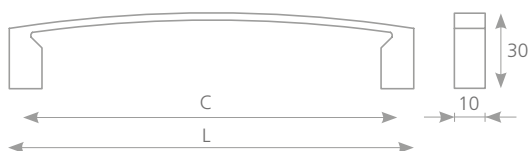

Kód / art.	C	L
42070	96	110
42072	128	140
42074	160	173

ARGUS X

Satin chrom / matt chrome



Kód / art.	C	L	H
42075	160	172	25
42077	160	172	35

KOVOVÉ ÚCHYTKY

METAL CABINET PULLS

ARGUS X

Imitace nerezí / stainless steel imitation

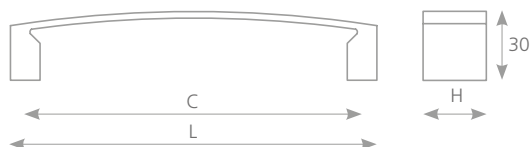

Kód / art.	C	L	H
42076	160	172	25
42078	160	172	35

CARINA

Chrom / polished chrome



Kód / art.	C	L
192361	96	103
192363	128	135

CARINA

Imitace nerezí / stainless steel imitation

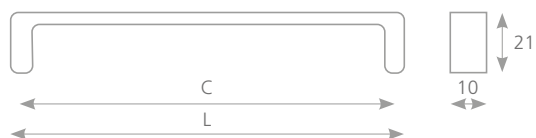

Kód / art.	C	L
192362	96	103
192364	128	135

KOVOVÉ ÚCHYTKY

METAL CABINET PULLS

DADA 028

Černá lesklá / glossy black



knopka DADA 060 (str. 127)
knob DADA 060 (pg. 127)

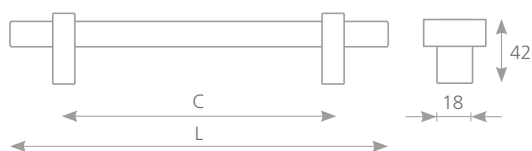

Kód / art.	C	L
157502	160	220
157503	192	252
157504	256	316
157505	320	380

DADA 050

Černá lesklá / glossy black



knopka DADA 060 (str. 127)
knob DADA 060 (pg. 127)

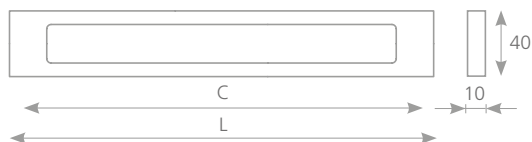

Kód / art.	C	L
157472	320	340

KOVOVÉ ÚCHYTKY

METAL CABINET PULLS

DADA 050

Černá matná / matt black

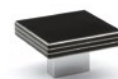

knopka DADA 060 (str. 127)
knob DADA 060 (pg. 127)

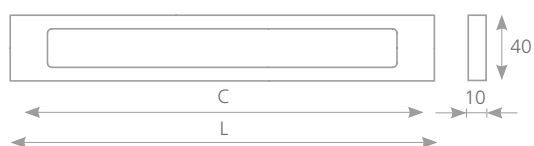

Kód / art.	C	L
157476	256	276
157477	320	340

DADA 050

Imitace nerezí / stainless steel imitation



knopka DADA 060 (str. 128)
knob DADA 060 (pg. 128)

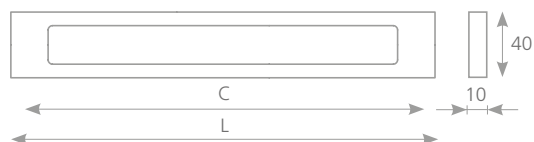

Kód / art.	C	L
157480	192	212
157483	384	404

KOVOVÉ ÚCHYTKY

METAL CABINET PULLS

DADA 100

Černá lesklá / glossy black

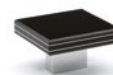

knopka DADA 060 (str. 127)
knob DADA 060 (pg. 127)

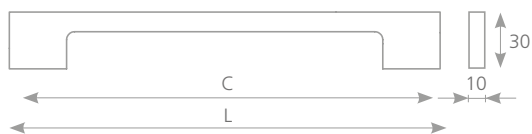

Kód / art.	C	L
157484	160	240
157485	192	272
157486	256	336
157487	320	400
157488	384	464

DADA 100

Černá matná / matt black

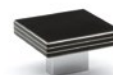
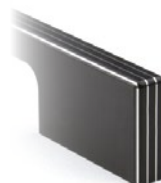

knopka DADA 060 (str. 127)
knob DADA 060 (pg. 127)

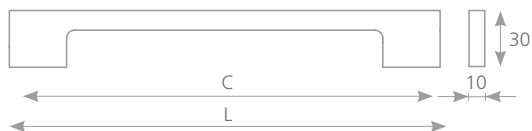

Kód / art.	C	L
157489	160	240
157490	192	272
157491	256	336
157492	320	400
157493	384	464

KOVOVÉ ÚCHYTKY

METAL CABINET PULLS

DADA 100

Imitace nerez / stainless steel imitation

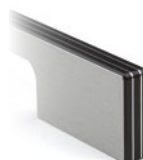

knopka DADA 060 (str. 128)
knob DADA 060 (pg. 128)

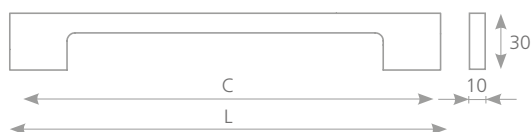

Kód / art.	C	L
157494	160	240
157495	192	272
157496	256	336
157497	320	400
157498	384	464

ENZA

Chrom / polished chrome



Kód / art.	C	L
US004	96	107
US001	128	140

KOVOVÉ ÚCHYTKY

METAL CABINET PULLS

ENZA

Chrom / polished chrome

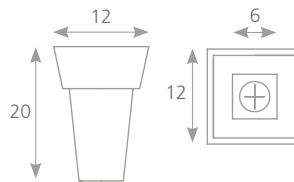

Kód / art.

US003

KUTTA

Chrom / polished chrome

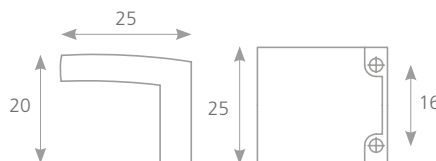

Kód / art.

US005

KUTTA

Chrom / polished chrome

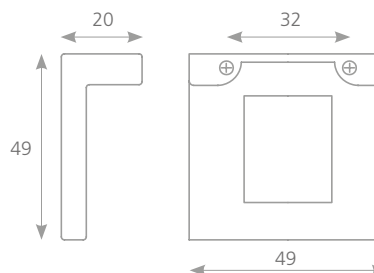

Kód / art.

US002

KOVOVÉ ÚCHYTKY

METAL CABINET PULLS

RUOTA

Chrom / polished chrome

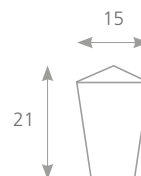

Kód / art.

US011

RUOTA

Chrom / polished chrome

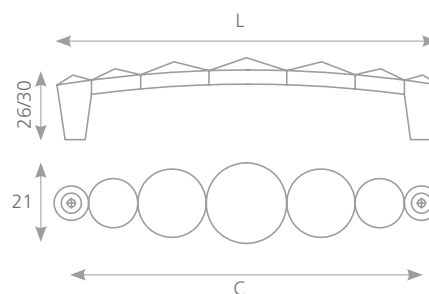

Kód / art.

C

L

US008

32

48

US007

96

114

US006

128

145

OSAKA

Chrom / polished chrome

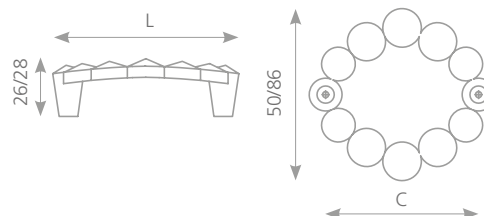

Kód / art.

C

L

US010

32

50

US009

64

86



Knopky
Metal knobs

KNOPKY

METAL KNOBS

FUNGO

Chrom / polished chrome

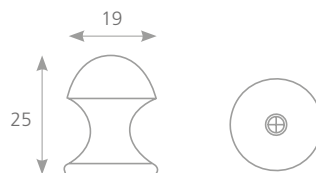

Kód / art.

37721

TOMIC

Satin nikl / matt nickel

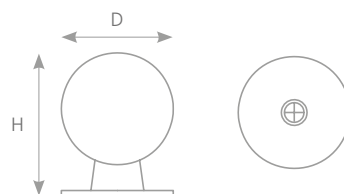

Kód / art.

D

H

35261

18

23

35271

25

32

TOMIC

Satin chrom / matt chrome

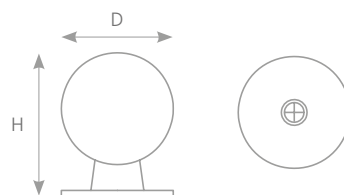

Kód / art.

D

H

35262

18

23

35272

25

32

TOMIC

Chrom / polished chrome

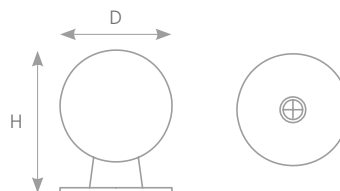

Kód / art.	D	H
35263	18	23
35273	25	32

TOMIC

Moszaz / brass

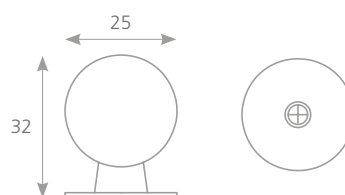

Kód / art.

35274

UKUDA

Satin nikl / matt nickel

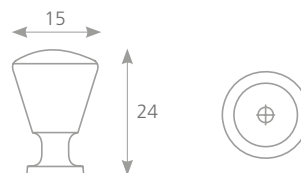

Kód / art.

157305

KNOPKY

METAL KNOBS

UKUDA

Satin chrom / matt chrome

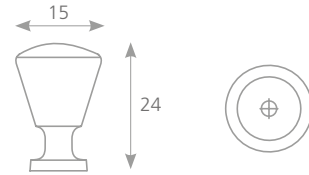

Kód / art.

157306

UKUDA

Chrom / polished chrome

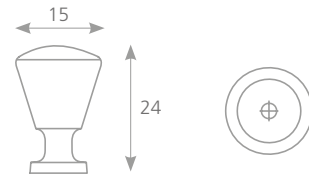

Kód / art.

157308

UKUDA

Broušený nikl / nickel brushed

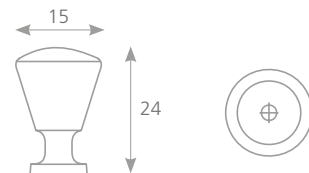

Kód / art.

157307

RUZA

Satin nikl / matt nickel

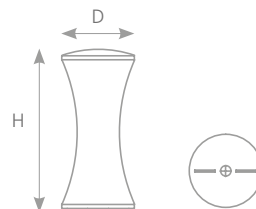

Kód / art.	D	H
157289	16	27
157294	21	35

RUZA

Satin chrom / matt chrome

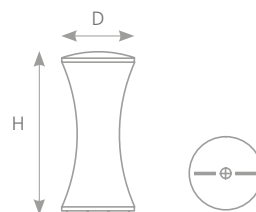

Kód / art.	D	H
157290	16	27
157295	21	35

RUZA

Chrom / polished chrome

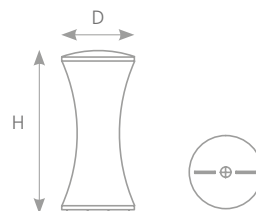

Kód / art.	D	H
157292	16	27
157297	21	35

KNOPKY

METAL KNOBS

RUZA

Broušený nikel / nickel brushed

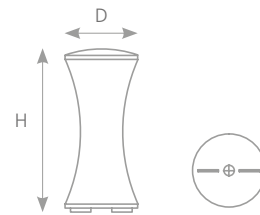

Kód / art.	D	H
157291	16	27
157296	21	35

RUZA

Černá / black

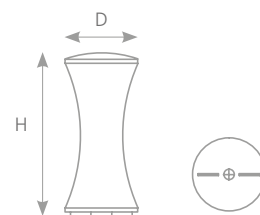

Kód / art.	D	H
157293	16	27
157299	21	35

JOTA

Satin nikel / matt nickel

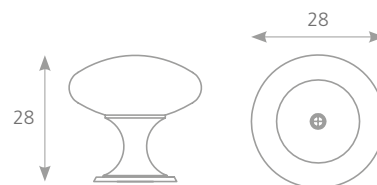

Kód / art.
35001

JOTA

Satin chrom / matt chrome

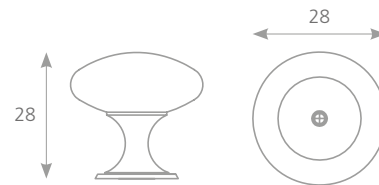

Kód / art.

35002

JOTA

Chrom / polished chrome

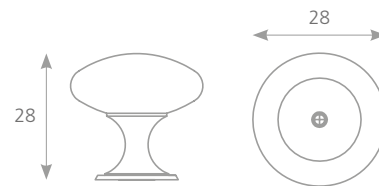

Kód / art.

35003

JOTA

Mosz / brass

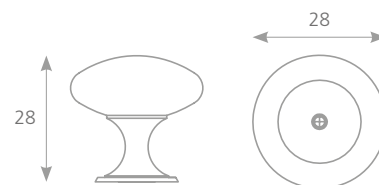

Kód / art.

35004

KNOPKY

METAL KNOBS

JOTA

Černá / black

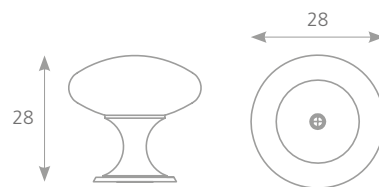

Kód / art.

35005

JOTA

Broušený nikel / nickel brushed

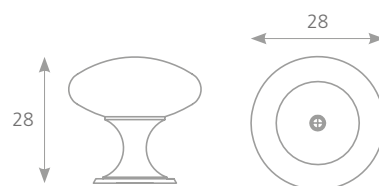

Kód / art.

35007

GALKA

Chrom / polished chrome

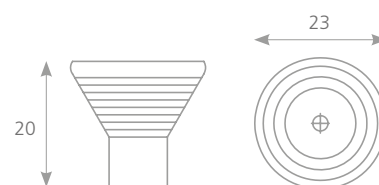

Kód / art.

07696

GALKA

Satin chrom / matt chrome

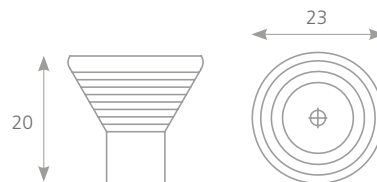

Kód / art.

07697

IROKO

Satin chrom / matt chrome



Kód / art.

37251

IROKO

Broušený nikel / nickel brushed



Kód / art.

37252

KNOPKY

METAL KNOBS

RUDA

Satin chrom / matt chrome

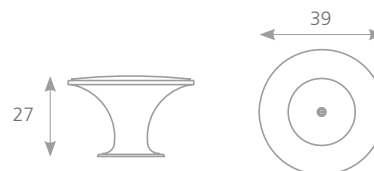

Kód / art.

35892

TURIA

Satin nikl / matt nickel

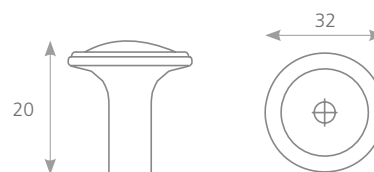

Kód / art.

157300

TURIA

Satin chrom / matt chrome

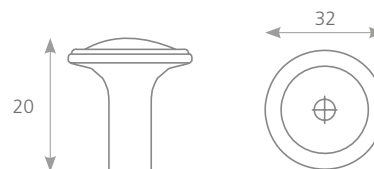

Kód / art.

157301

TURIA

Chrom / polished chrome

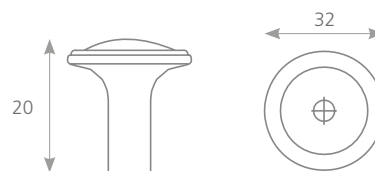

Kód / art.

157303

TURIA

Broušený nikel / nickel brushed

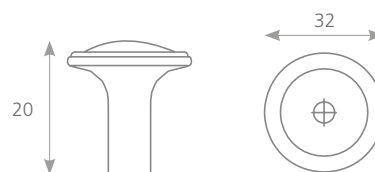

Kód / art.

157302

TURIA

Staromosaz / old brass

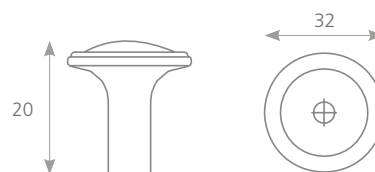

Kód / art.

157304

KNOPKY

METAL KNOBS

MARUSA

Satin nikl / matt nickel



Kód / art.

35171

MARUSA

Satin chrom / matt chrome

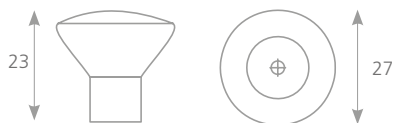

Kód / art.

35172

MARUSA

Chrom / polished chrome



Kód / art.

35173

MATEO

Satin nikl / matt nickel

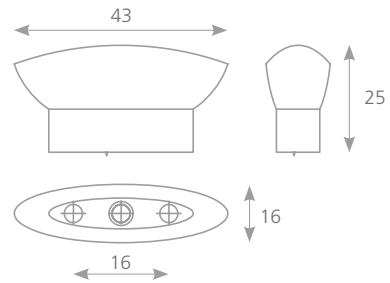

Kód / art.

35521

MATEO

Satin chrom / matt chrome

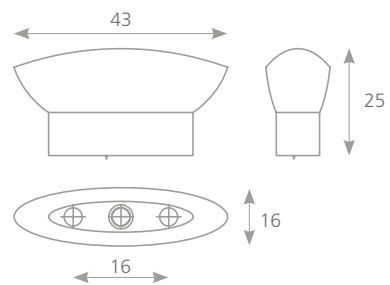

Kód / art.

35522

PORESA

Satin nikl / matt nickel

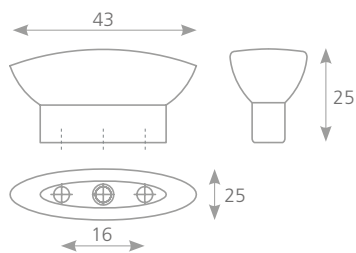

Kód / art.

35551

KNOPKY

METAL KNOBS

PORESA

Satin chrom / matt chrome

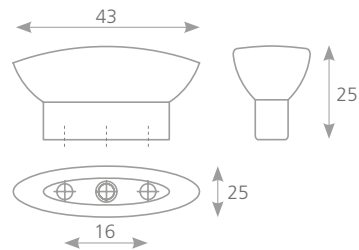

Kód / art.

35552

SETAN

Satin chrom / matt chrome

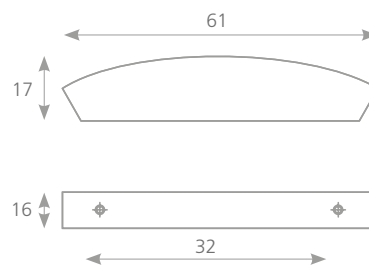

Kód / art.

157238

SETAN

Chrom / polished chrome

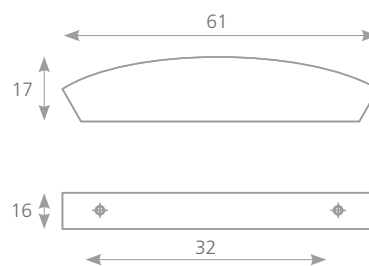

Kód / art.

157239

SETAN

Broušený nikel / nickel brushed

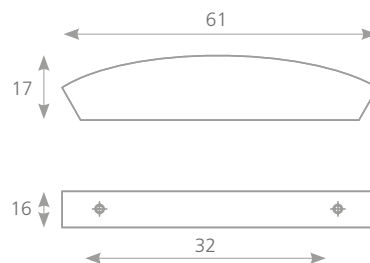

Kód / art.

157240

RAPPA

Chrom / polished chrome

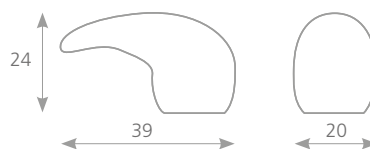

Kód / art.

35006

TUCANA

Satin chrom / matt chrome

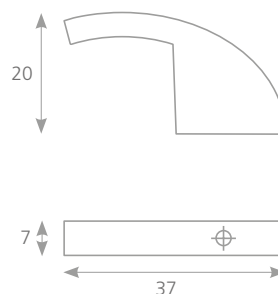

Kód / art.

37162

KNOPKY

METAL KNOBS

LUNA

Imitace nerezi / stainless steel imitation

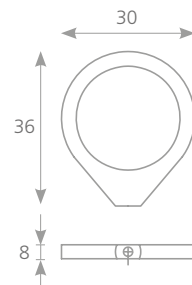

Kód / art.

42004

BELUGA

Satin chrom / matt chrome



úchytká BELUGA (str. 91)
pull BELUGA (pg. 91)

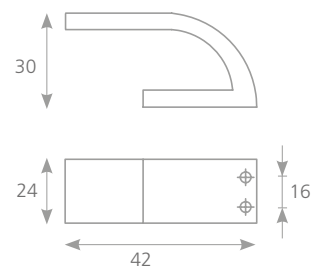

Kód / art.

42056

BELUGA

Imitace nerezi / stainless steel imitation



úchytká BELUGA (str. 98)
pull BELUGA (pg. 98)

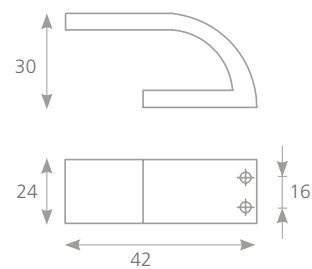

Kód / art.

42057

FORO

Stříbrná / silver



úchytka FORO (str. 48)
pull FORO (pg. 48)

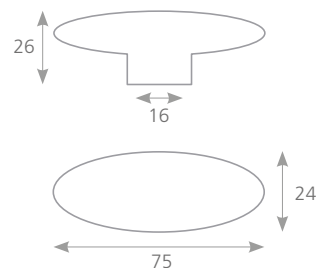

Kód / art.

77822

WHALE

Satin chrom / matt chrome

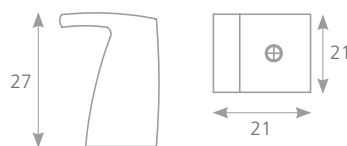

Kód / art.

42029

WHALE

Imitace nerezi / stainless steel imitation

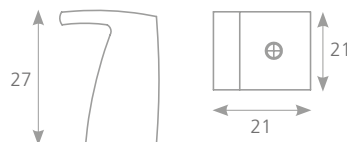

Kód / art.

42030

KNOPKY

METAL KNOBS

OTA

Nerez / stainless steel



Kód / art.

202884

ZOLA

Satin chrom / matt chrome

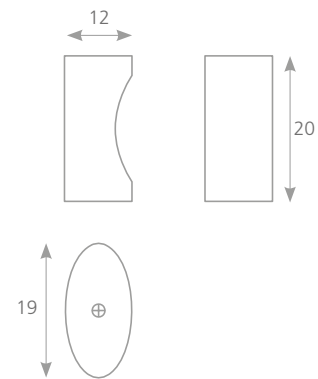

Kód / art.

37181

TINTO

Satin chrom / matt chrome

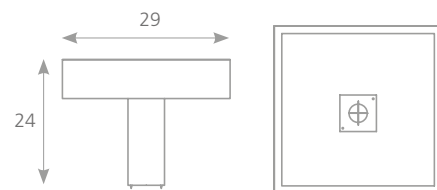

Kód / art.

36313

TINTO

Chrom / polished chrome

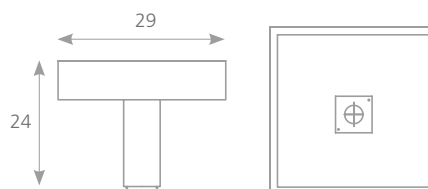

Kód / art.

36314

DADA 060

Černá lesklá / glossy black

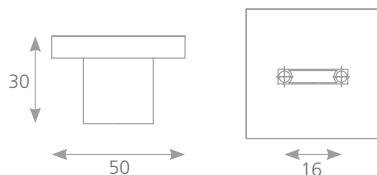
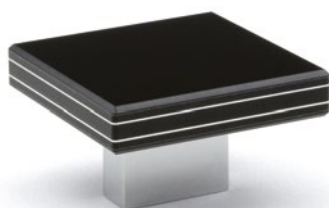

úchytka DADA 100 (str. 105)
pull DADA 100 (pg. 105)



úchytka DADA 028 (str. 103)
pull DADA 028 (pg. 103)



úchytka DADA 050 (str. 103)
pull DADA 050 (pg. 103)

Kód / art.

157499

DADA 060

Černá matná / matt black

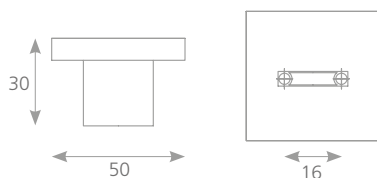
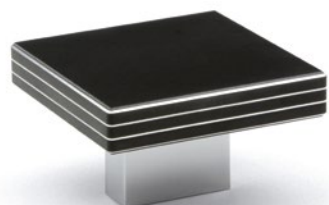

úchytka DADA 100 (str. 105)
pull DADA 100 (pg. 105)



úchytka DADA 050 (str. 104)
pull DADA 050 (pg. 104)

Kód / art.

157500

KNOPKY

METAL KNOBS

DADA 060

Imitace nerezi / stainless steel imitation

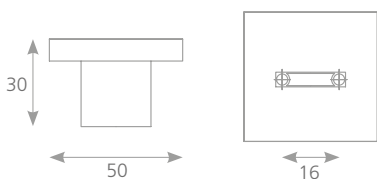
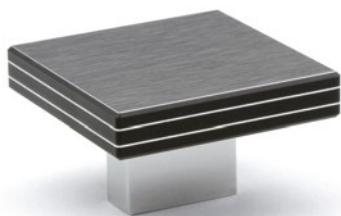

úchytka DADA 100 (str. 106)
pull DADA 100 (pg. 106)



úchytka DADA 050 (str. 104)
pull DADA 050 (pg. 104)

Kód / art.

157501

BLOCK

Imitace nerezi / stainless steel imitation

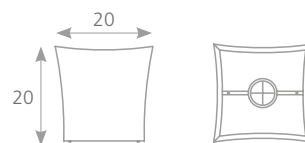

Kód / art.

42099

FRAME

Imitace nerezi / stainless steel imitation

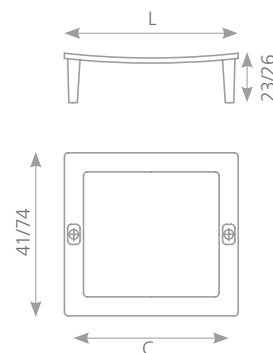

Kód / art.

C

L

42096

32

41

42095

64

74

RITTO

Hliník / aluminium

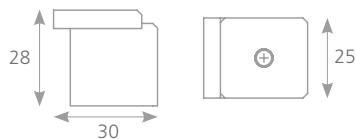

úchytka RITTO (str. 49)
pull RITTO (pg. 49)



věšák RITTO (str. 262)
hook RITTO (pg. 262)

Kód / art.

UG001

RITTO

Chrom / polished chrome

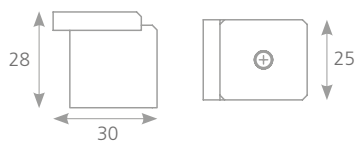

úchytka RITTO (str. 50)
pull RITTO (pg. 50)

Kód / art.

UG002

RITTO

Černá mat / zkosená hrana
Matt black / bevel edge

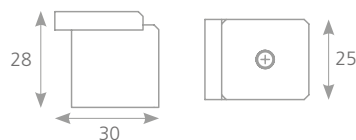

úchytka RITTO (str. 50)
pull RITTO (pg. 50)

Kód / art.

UG003 •

KNOPKY

METAL KNOBS

RITTO

Černá mat / zbroúšená hrana
Matt black / grinded edge

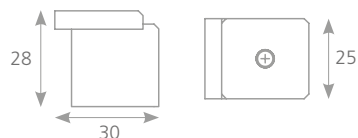

úchytka RITTO (str. 49)
pull RITTO (pg. 49)

Kód / art.

UG004

TACA

Chrom lesklý / imitace nerezí
Polished chrome / stainless steel imitation

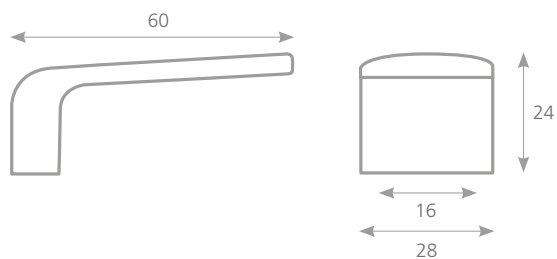

úchytka TACA (str. 19)
pull TACA (pg. 19)

Kód / art.

246019

TACA

Chrom lesklý / bílá
Polished chrome / white

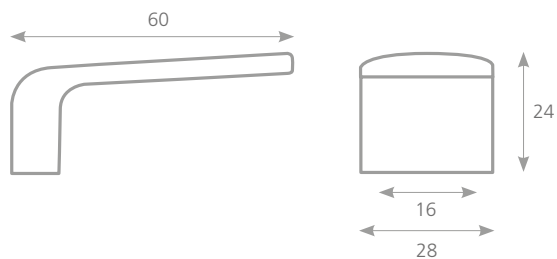

úchytka TACA (str. 19)
pull TACA (pg. 19)

Kód / art.

246011



TACA

Chrom lesklý / hliník

Polished chrome / aluminium

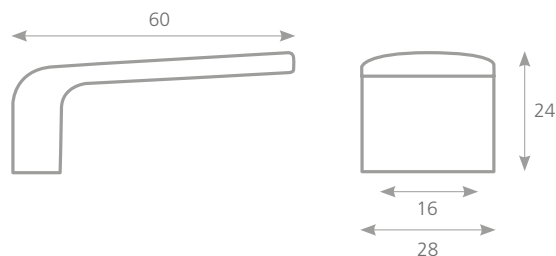

úchytká TACA (str. 18)
pull TACA (pg. 18)

Kód / art.
246015

KNOPKY

METAL KNOBS

PRISMA

Satin chrom / matt chrome

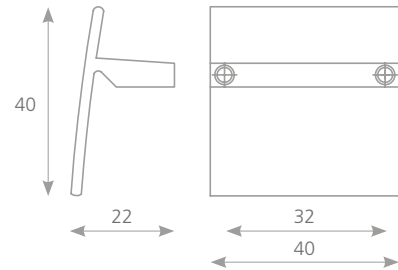

Kód / art.

42016

PRISMA

Imitace nerezi / stainless steel imitation

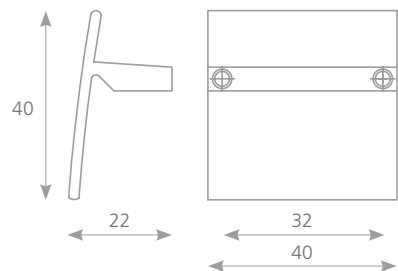
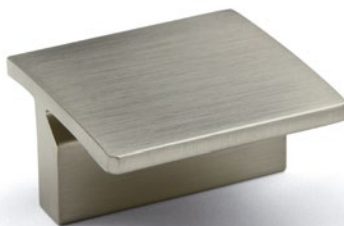

Kód / art.

42017

VINTAGE S

Satin chrom / matt chrome

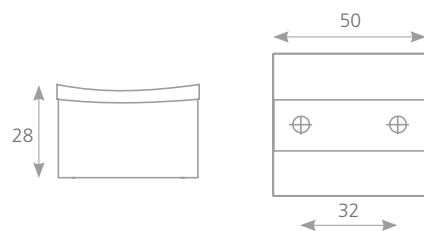

Kód / art.

157647

VINTAGE S

Imitace nerezi / stainless steel imitation

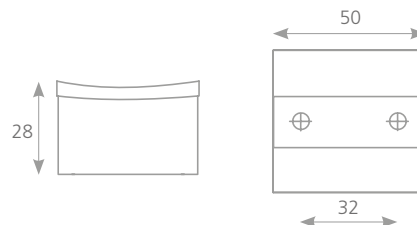

Kód / art.

157648

VINTAGE O

Satin chrom / matt chrome

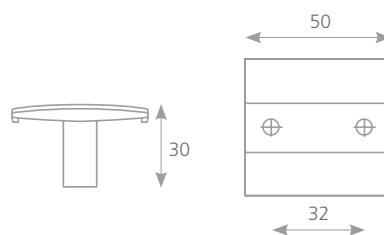

Kód / art.

157649

VINTAGE O

Imitace nerezi / stainless steel imitation

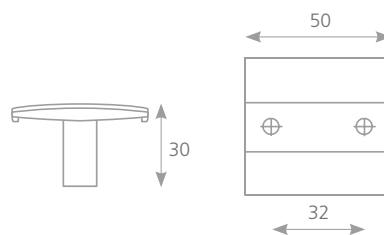

Kód / art.

157651

KNOPKY

METAL KNOBS

VINTAGE O

Černá / black

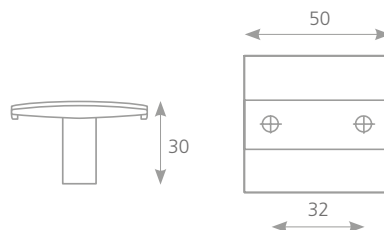

Kód / art.

157653

VINTAGE O

Bílá / white

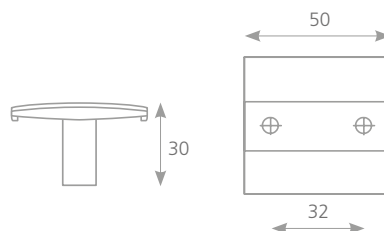

Kód / art.

157652

VINTAGE ST

Satin chrom / matt chrome

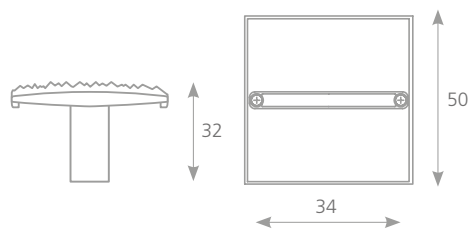

Kód / art.

42083

VINTAGE ST

Patinovaný bronz / patinated bronze

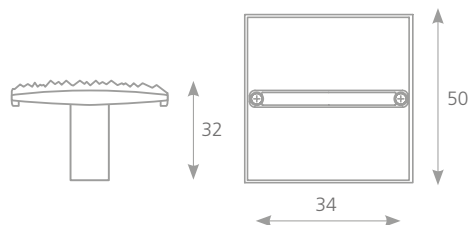

Kód / art.

42084

VINTAGE RT

Patinovaný bronz / patinated bronze

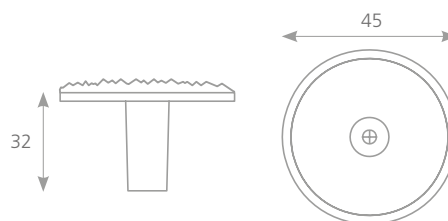

Kód / art.

42086

VINTAGE R

Imitace nerezi / stainless steel imitation

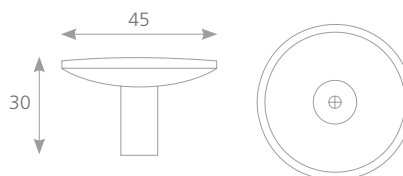

Kód / art.

157646

KNOPKY

METAL KNOBS

SEKOL

Antik English / antique English



úchytka SEKOL (str. 58)
pull SEKOL (pg. 58)

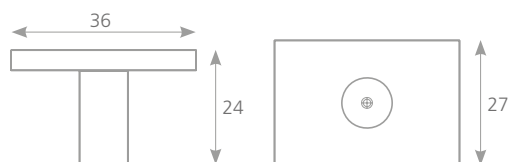

Kód / art.

157267

SEKOL

Chrom / polished chrome



úchytka SEKOL (str. 58)
pull SEKOL (pg. 58)

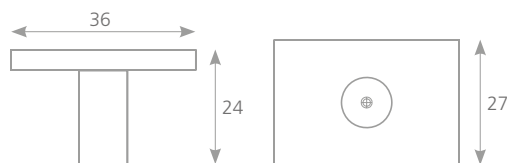

Kód / art.

157269

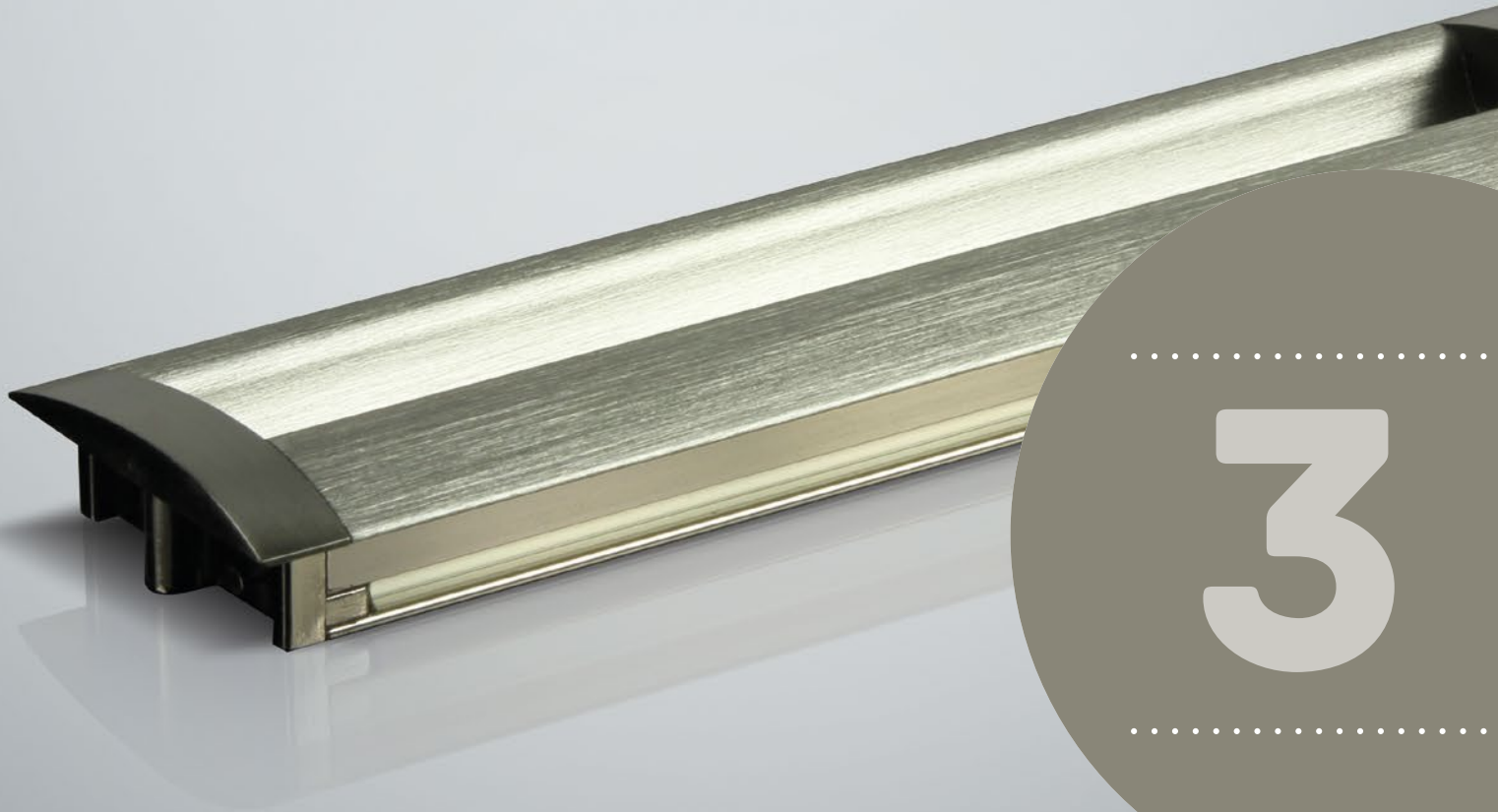

Zápustné úchytky
Recessed handles



ZÁPUSTNÉ ÚCHYTKY

RECESSED HANDLES

PISTA

Imitace nerez / stainless steel imitation



Kód / art.	C	L	Rozměry zhloubení (frézování) mounting sizes (recess)
206136	128	143	137 x 38 x 14
206137	192	207	201 x 38 x 14
206138	320	335	329 x 38 x 14
206139	Samostatný profil 1000 mm / Profile for handle Pista – 1000 mm		
202853	Koncovka k profilu 206139 – LEVÁ / End cap for handle Pista – left		
202854	Koncovka k profilu 206139 – PRAVÁ / End cap for handle Pista – right		

RAPID

Stříbrná / silver

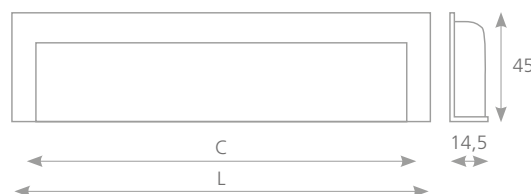

Kód / art.	C	L	Rozměry zhloubení (frézování) mounting sizes (recess)
215529	160	171	167 x 40 x 12,5

ZÁPUSTNÉ ÚCHYTKY

RECESSED HANDLES

ORINOCO

Stříbrná / silver



Kód / art.	C	L	Rozměry zhloubení (frézování) mounting sizes (recess)
157785	96	106	102 × 27 × 11
37201	128	138	134 × 27 × 11

UNTA

Satin chrom / matt chrome

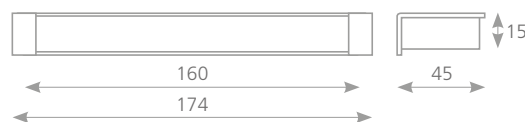

Kód / art.	Rozměry zhloubení (frézování) mounting sizes (recess)
07639	164 × 40 × 15

MALUKA

Imitace nerez / stainless steel imitation



Kód / art.	C	L	Rozměry zhloubení (frézování) mounting sizes (recess)
157514	128	143	138 × 42,3 × 14,2
157515	160	175	170 × 42,3 × 14,2
157516	192	207	202 × 42,3 × 14,2
157517	256	271	266 × 42,3 × 14,2

ZÁPUSTNÉ ÚCHYTKY

RECESSED HANDLES

MALUKA

Hliník / aluminium



Kód / art.	C	L	Rozměry zhloubení (frézování) mounting sizes (recess)
157510	128	143	138 x 42,3 x 14,2
157511	160	175	170 x 42,3 x 14,2
157512	192	207	202 x 42,3 x 14,2
157513	256	271	266 x 42,3 x 14,2

NAVE

Hliník / aluminium

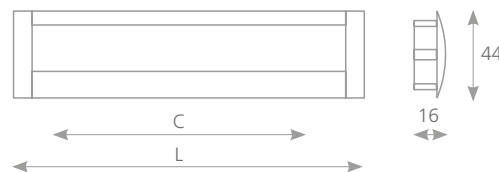

Kód / art.	C	L
225013	96	106
225014	160	170
225015	320	330
225016	480	490

NAVE

Imitace nerez / stainless steel imitation

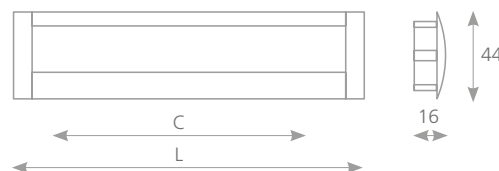

Kód / art.	C	L
225017	96	206
225018	160	334
225041	320	494
225042	480	686



MALENA

Imitace nerezí / stainless steel imitation

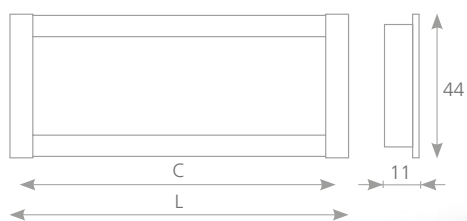
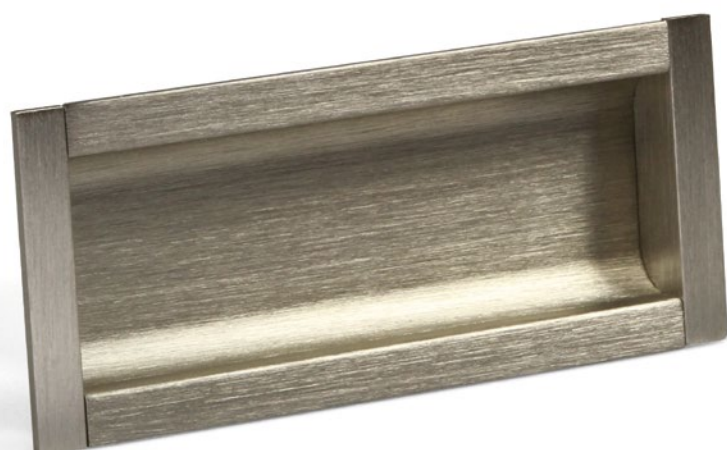

Kód / art.	C	L	Rozměry zhloubení (frézování) mounting sizes (recess)
226999	96	104	98 × 38 × 9
227000	192	215	209 × 38 × 9

ZÁPUSTNÉ ÚCHYTKY

RECESSED HANDLES

MALENA

Hliník / aluminium

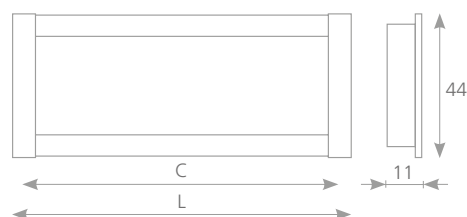

TIP: lze použít na posuvné dveře tloušťky 18 mm / can be used for sliding doors of thickness 18 mm.

Kód / art.	C	L	Rozměry zhloubení (frézování) mounting sizes (recess)
226997	96	104	98 × 38 × 9
226998	192	215	209 × 38 × 9

CONCAVA

Matný bílý chrom / chrom
Matt white chrome / polished chrome



Kód / art.	C	L	Rozměry zhloubení (frézování) mounting sizes (recess)
37331	96	109	103 × 36 × 14
157776	128	140	137 × 36 × 14
37191	160	171	167 × 36 × 14

CONCAVA

Satin chrom / matt chrome

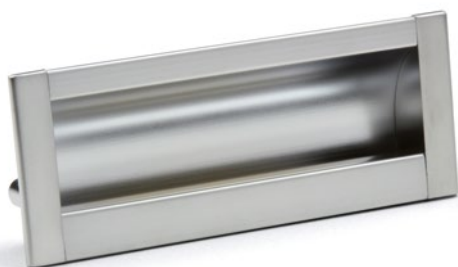

Kód / art.	C	L	Rozměry zhloubení (frézování) mounting sizes (recess)
37332	96	109	103 × 36 × 14
157777	128	140	137 × 36 × 14
37192	160	171	167 × 36 × 14

ZÁPUSTNÉ ÚCHYTKY

RECESSED HANDLES

CONCAVA

Broušený nikel / nickel brushed



Kód / art.	C	L	Rozměry zhloubení (frézování) mounting sizes (recess)
37333	96	109	103 × 36 × 14
157778	128	140	137 × 36 × 14
37193	160	171	167 × 36 × 14

RULIDA

Stříbrná / silver

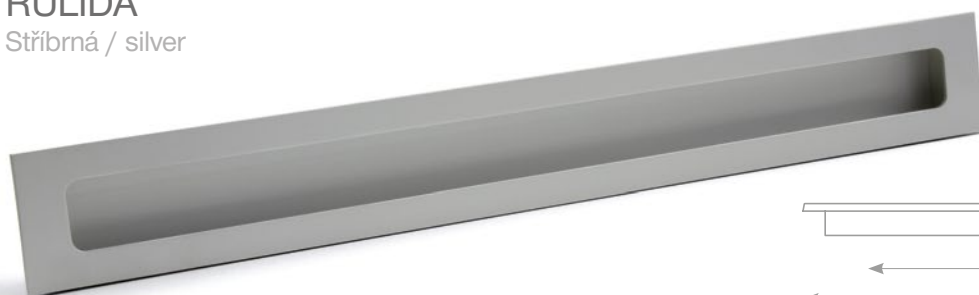

Kód / art.	C	L	Rozměry zhloubení (frézování) mounting sizes (recess)
37006	128	145	136 × 33 × 14
37007	256	278	267 × 33 × 14
37008	320	337	327 × 33 × 14
37009	544	561	556 × 33 × 14

COMOLA

Satin chrom / matt chrome

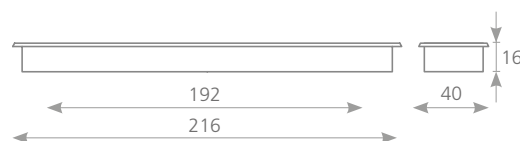

Kód / art.	Rozměry zhloubení (frézování) mounting sizes (recess)
205123	211 × 35 × 14

ZÁPUSTNÉ ÚCHYTKY

RECESSED HANDLES

SWIFT

Imitace nerez / stainless steel imitation

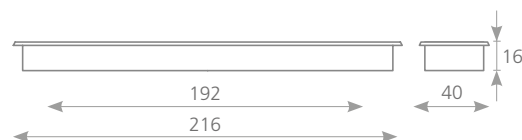

Kód / art.

Rozměry zhloubení (frézování)
mounting sizes (recess)

42112

211 × 35 × 14

SWIFT

Patinovaný tmavý bronz / patinated dark bronze



Kód / art.

Rozměry zhloubení (frézování)
mounting sizes (recess)

157579

211 × 35 × 14

ZÁPUSTNÉ ÚCHYTKY

RECESSED HANDLES

ILITA

Satin chrom / matt chrome



Kód / art.

Rozměry zahloubení (frézování)
mounting sizes (recess)

07641

140 × 38 × 14

PESARA

Satin chrom / matt chrome



Kód / art.

C

L

Rozměry zahloubení (frézování)
mounting sizes (recess)

157783

96

107

102 × 28 × 10

37781

128

139

135 × 28 × 10

PESARA

Satin nikl / matt nickel



Kód / art.

C

L

Rozměry zahloubení (frézování)
mounting sizes (recess)

157784

96

107

102 × 28 × 10

37783

128

139

135 × 28 × 10

ZÁPUSTNÉ ÚCHYTKY

RECESSED HANDLES

PESARA

Broušený nikel / nickel brushed



Kód / art.	C	L	Rozměry zhloubení (frézování) mounting sizes (recess)
157782	96	107	102 × 28 × 10
157781	128	139	135 × 28 × 10

MADRID

Stříbrná / silver



Kód / art.	Rozměry zhloubení (frézování) mounting sizes (recess)
36334	142,6 × 30 × 12

ZÁPUSTNÉ ÚCHYTKY

RECESSED HANDLES

CESARO

Chrom broušený / matt chrome brushed

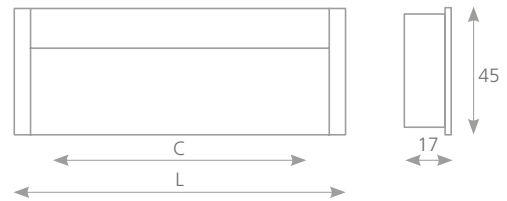

Kód / art.	C	L	Rozměry zahloubení (frézování) mounting sizes (recess)
192355	96	119	114,5 x 40 x 15
192358	160	183	168,5 x 40 x 15

CESARO

Chrom / polished chrome

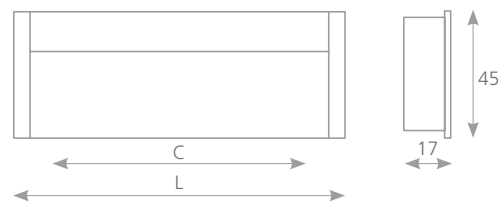

Kód / art.	C	L	Rozměry zahloubení (frézování) mounting sizes (recess)
192356	96	119	114,5 x 40 x 15
192359	160	183	168,5 x 40 x 15

ZÁPUSTNÉ ÚCHYTKY

RECESSED HANDLES

CESARO

Imitace nerez / stainless steel imitation

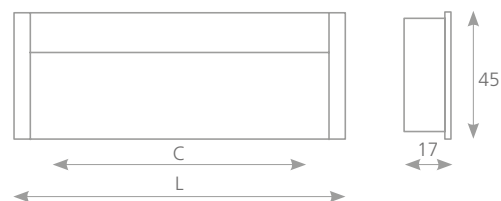
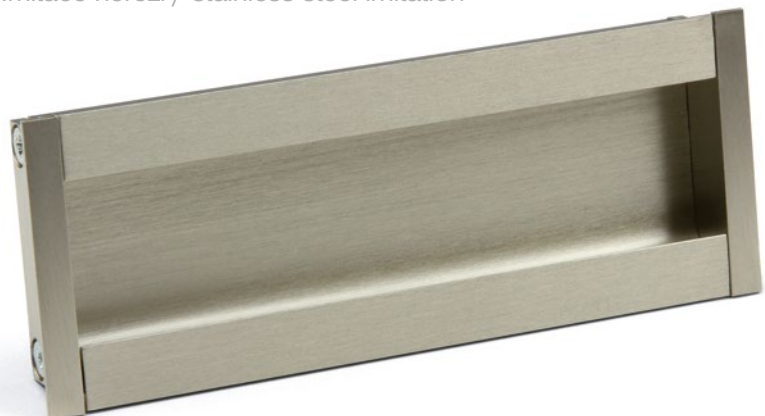

Kód / art.	C	L	Rozměry zhloubení (frézování) mounting sizes (recess)
192357	96	119	114,5 x 40 x 15
192360	160	183	168,5 x 40 x 15
203961	320	343	328,5 x 40 x 15
203964	480	503	488,5 x 40 x 15

ANETTA

Stříbrná / silver

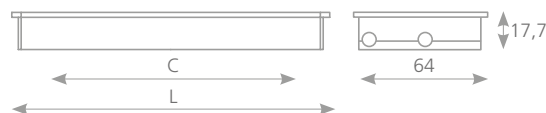

Kód / art.	C	L	Rozměry zhloubení (frézování) mounting sizes (recess)
37870	96	120	114 x 57,5 x 14,5
37871	128	150	144 x 57,5 x 14,5
37872	160	190	184 x 57,5 x 14,5
37873	192	246	240 x 57,5 x 14,5
37874	224	270	264 x 57,5 x 14,5
37875	256	296	290 x 57,5 x 14,5
37877	480	520	514 x 57,5 x 14,5
37878	672	712	706 x 57,5 x 14,5

ZÁPUSTNÉ ÚCHYTKY

RECESSED HANDLES

UTARA

Broušený nikel / nickel brushed

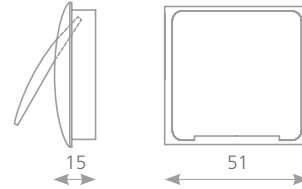

Kód / art.

Rozměry zhloubení (frézování)
mounting sizes (recess)

37261

46 × 46 × 10,2

UTARA

Satin chrom / matt chrome

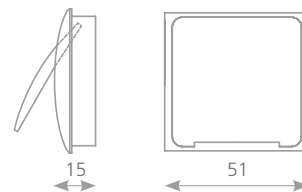

Kód / art.

Rozměry zhloubení (frézování)
mounting sizes (recess)

37262

46 × 46 × 10,2

PORTOS L

Satin chrom / matt chrome

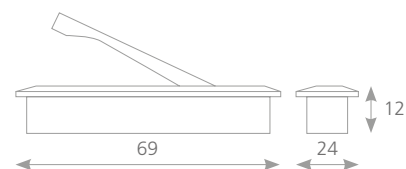

Kód / art.

Rozměry zhloubení (frézování)
mounting sizes (recess)

226935

64 × 19 × 10

ZÁPUSTNÉ ÚCHYTKY

RECESSED HANDLES

MUDA

Satin nikl / matt nickel

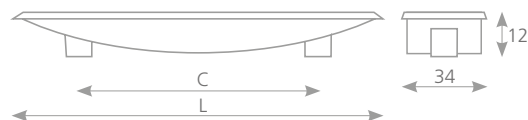

Kód / art.	C	L	Rozměry zhloubení (frézování) mounting sizes (recess)
202969	64	100	96 x 34 x 11
202967	128	150	146 x 34 x 11

MUDA

Satin chrom / matt chrome

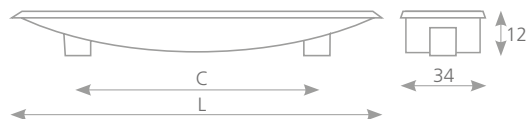

Kód / art.	C	L	Rozměry zhloubení (frézování) mounting sizes (recess)
202968	64	100	96 x 34 x 11
202970	128	150	146 x 34 x 11

MANE

Stříbrná / silver

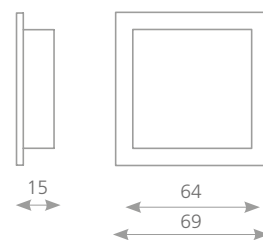

Kód / art.	Rozměry zhloubení (frézování) mounting sizes (recess)
77823	63,2 x 63,2 x 13

ZÁPUSTNÉ ÚCHYTKY

RECESSED HANDLES

AVOCA

Satin nikl / matt nickel



Kód / art.

37773

Rozměry zhloubení (frézování)
mounting sizes (recess)

82 × 26,5 × 9

AVOCA

Satin chrom / matt chrome

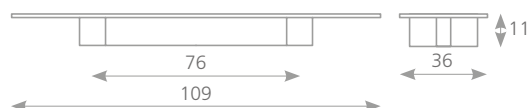

Kód / art.

37771

Rozměry zhloubení (frézování)
mounting sizes (recess)

82 × 26,5 × 9

AVOCA

Broušený nikl / nickel brushed

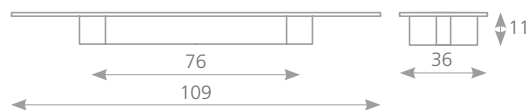

Kód / art.

157779

Rozměry zhloubení (frézování)
mounting sizes (recess)

82 × 26,5 × 9

ZÁPUSTNÉ ÚCHYTKY

RECESSED HANDLES

KANIVA

Satin nikl / matt nickel

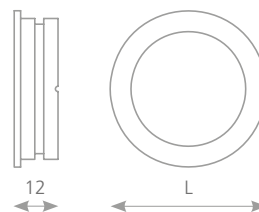

Kód / art.	L	Rozměry zhloubení (frézování) mounting sizes (recess)
35531	40	35 × 35 × 10
35541	50	42 × 42 × 10

KANIVA

Satin chrom / matt chrome

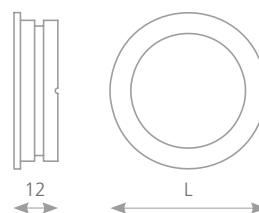

Kód / art.	L	Rozměry zhloubení (frézování) mounting sizes (recess)
35532	40	35 × 35 × 10
35542	50	42 × 42 × 10

KANIVA

Chrom / polished chrome

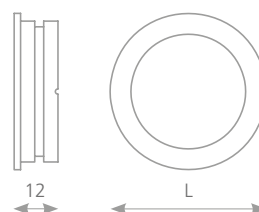

Kód / art.	L	Rozměry zhloubení (frézování) mounting sizes (recess)
35533	40	35 × 35 × 10
35543	50	42 × 42 × 10

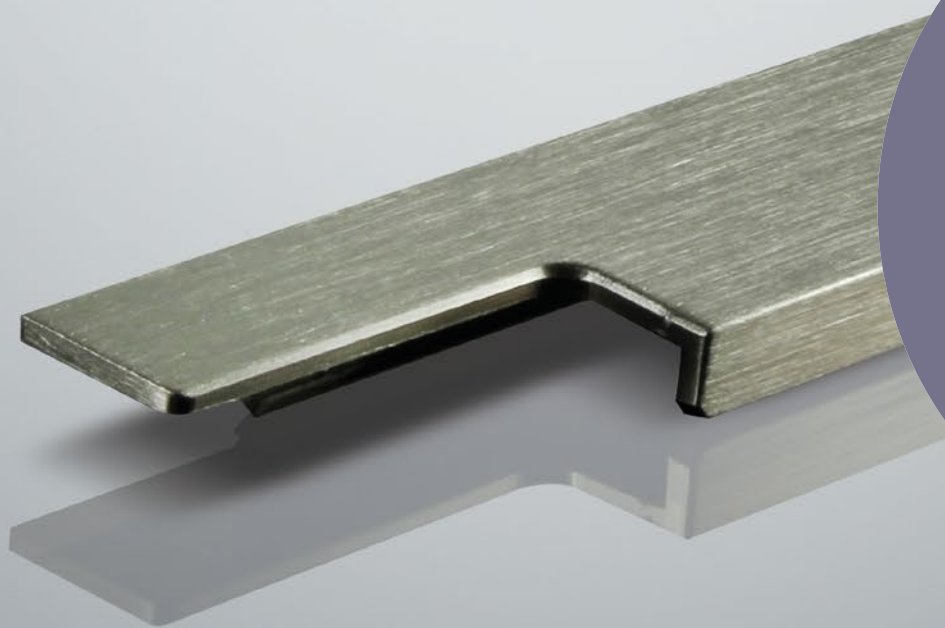

Narážecí profily
Aluminium edge banding handles



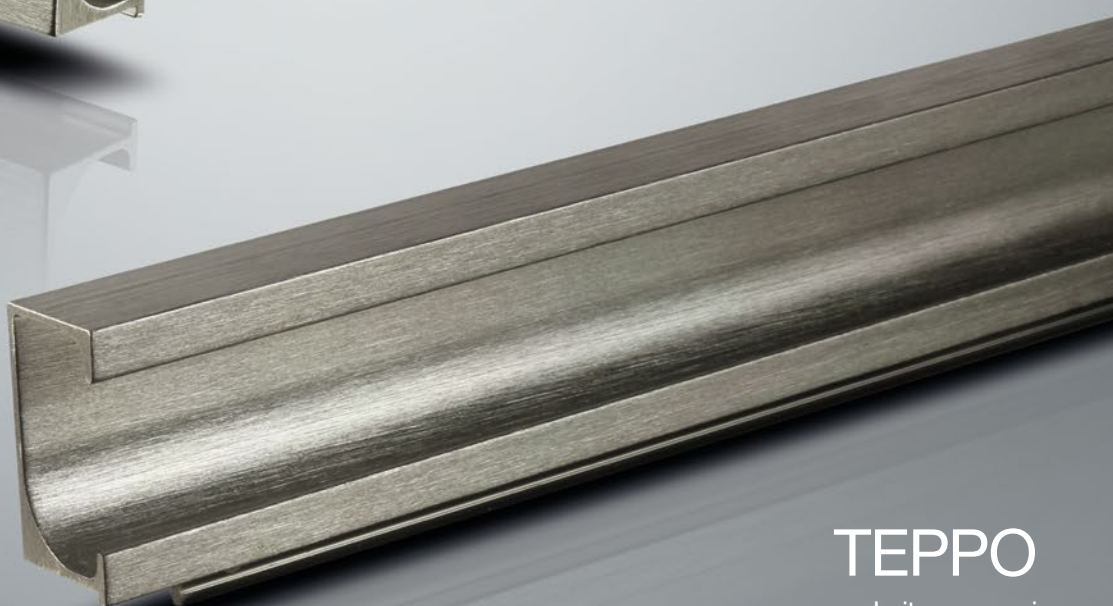

TEPPO

Imitace nerezí
Stainless steel imitation

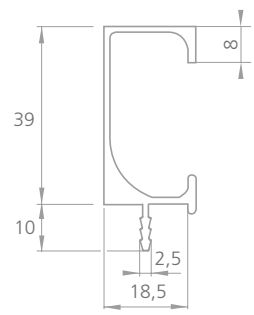

www.tulip-design.com

Kód / art.	L	Kód / art.	L
205113	297	205118	597
205114	347	205119	797
205115	397	205120	897
205116	447	205121	997
205117	497	205122	1197
		264488 •	1500

NARÁŽECÍ PROFILY

ALUMINIUM EDGE BANDING HANDLES

TEPPO

Hliník / aluminium

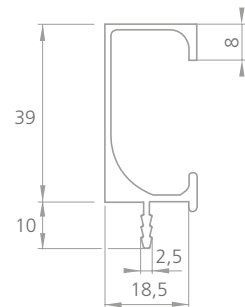
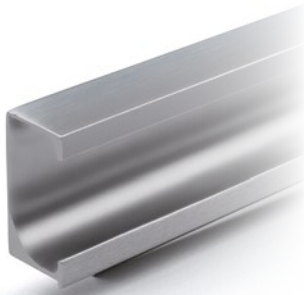

Kód / art.

L

202875

3000

PAOLO

Hliník / aluminium

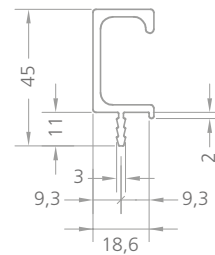
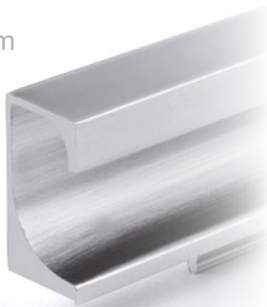

Kód / art.

L

215271

597

215272

797

215273

897

215274

997

215275

1197

215276

3000

Kód / art.

L

215266

297

215267

347

215268

397

215269

447

215270

497

FANO

Hliník / aluminium

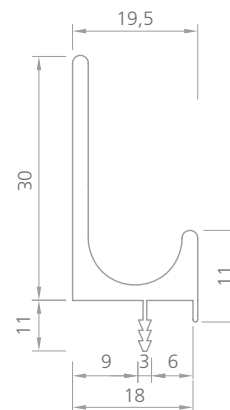

Kód / art.

L

UC001

2450

NARÁŽECÍ PROFILY

ALUMINIUM EDGE BANDING HANDLES

JUVIO

Imitace nerezzi
Stainless steel imitation

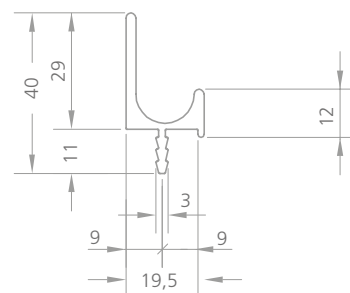

Kód / art.	L
202858	297
202859	347
202860	397
202861	447
202862	497

Kód / art.	L
202863	597
202864	797
202865	897
202866	997
202867	1197
264487 •	1500

JUVIO

Hliník / aluminium

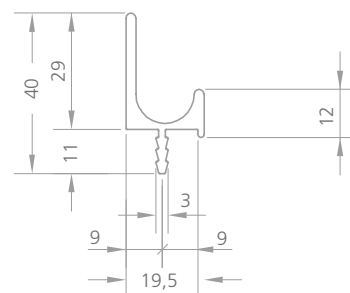
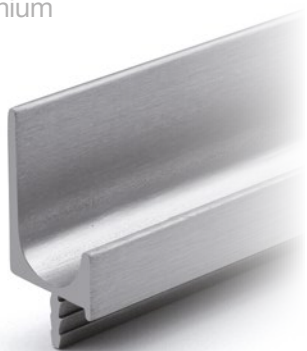

Kód / art.	L
202868	3000

RAMARA

Hliník / aluminium

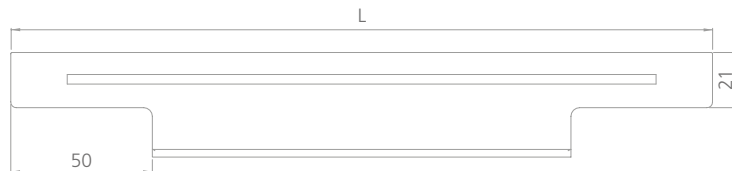
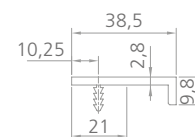

Kód / art.	L
244834	146
244835	196
244836	296
244837	346
244838	396
244839	446

Kód / art.	L
244840	496
244841	596
244842	796
244843	896
244844	996
244845	1196

NARÁŽECÍ PROFILY

ALUMINIUM EDGE BANDING HANDLES

RAMARA

Imitace nerezí
Stainless steel imitation

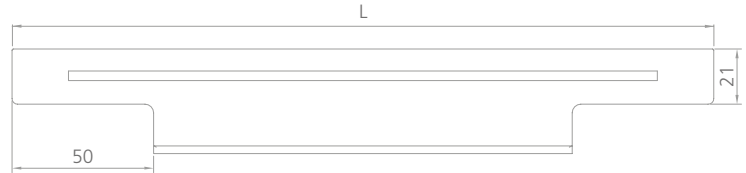
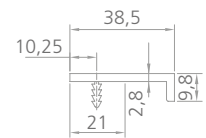

Kód / art.	L
244831	146
244832	196
202816	296
202817	346
244833	396
202818	446

Kód / art.	L
202819	496
202820	596
202821	796
202822	896
202823	996
202824	1196

TORINO

Hliník / aluminium

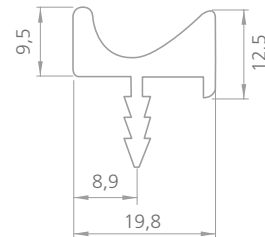

Kód / art.	L
• 267568	2450

PIANO

Hliník / aluminium

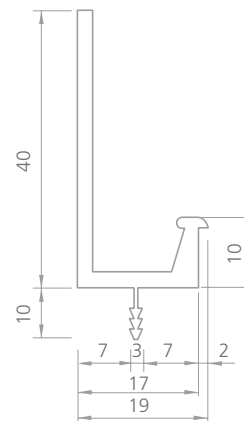

Kód / art.	L
UC002	2450

NARÁŽECÍ PROFILY

ALUMINIUM EDGE BANDING HANDLES

FLATA

Chrom / polished chrome

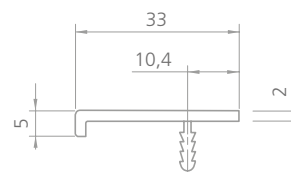

Kód / art.	L
36358	70
36362	348
169436	478
169437	578

Kód / art.	L
36364	593
36366	688
169438	778
169439	978

LUCATA

Chrom lesklý / polished chrome

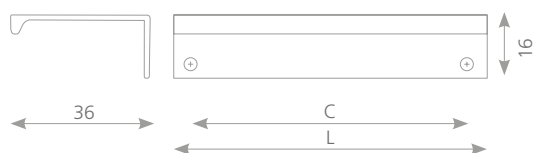
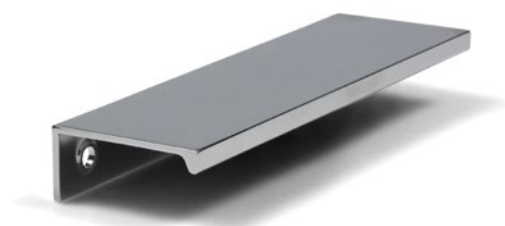

Kód / art.	C	L
227265	32	52
227266	64	84
227267	96	116
227269	160	180
227270	320	340

LUCATA

Hliník / aluminium

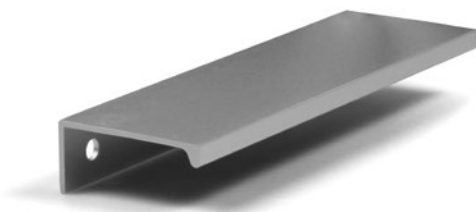

Kód / art.	C	L
227276	32	52
227277	64	84
227278	96	116
227279	160	180
227280	320	340



LUCATA

Imitace nerezi / stainless steel imitation

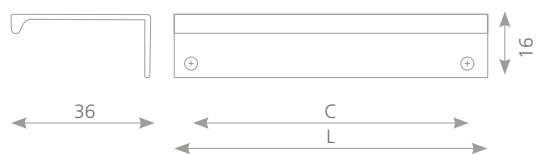
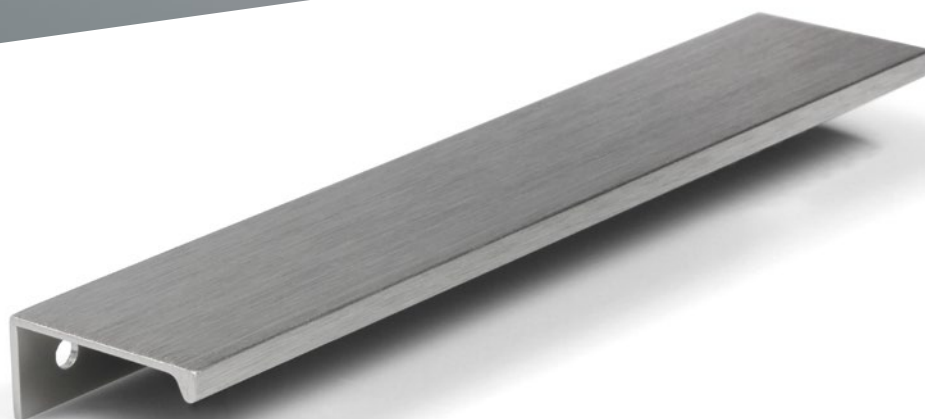

Kód / art.	C	L
227271	32	52
227272	64	84
227273	96	116
227274	160	180
227275	320	340

NARÁŽECÍ PROFILY

ALUMINIUM EDGE BANDING HANDLES

LUNGO

Hliník / aluminium

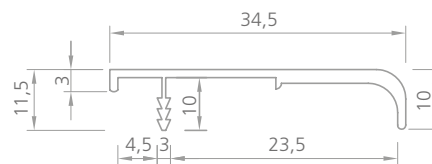

Kód / art.

L

UC004

3000



Rustikální úchytky
Classical handles



RUSTIKÁLNÍ ÚCHYTKY

CLASSICAL HANDLES

DERBY

Staročerná / used black look

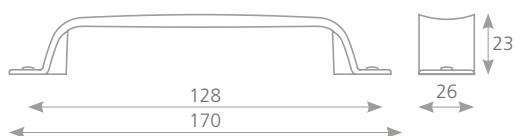

Kód / art.

202825

DERBY

Černá ocel lesk / pewter

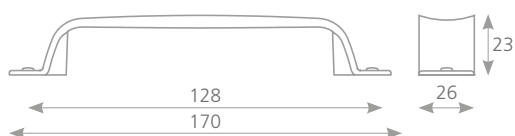

Kód / art.

202826

DERBY

Černá ocel mat / matt old steel

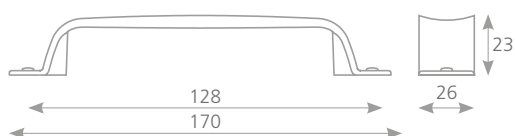

Kód / art.

202827

RUSTIKÁLNÍ ÚCHYTKY

CLASSICAL HANDLES

SULKY

Staročerná / used black look

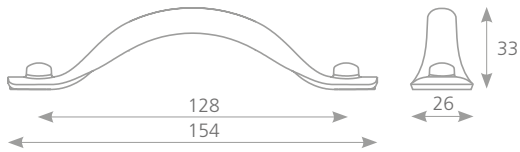

Kód / art.

202828

SULKY

Černá ocel lesk / pewter

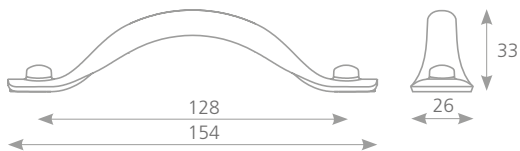

Kód / art.

202829

SULKY

Černá ocel mat / matt old steel

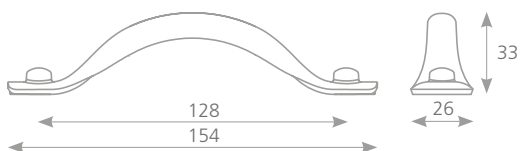

Kód / art.

202830

RUSTIKÁLNÍ ÚCHYTKY

CLASSICAL HANDLES

KENTUCKY DS

Staročerná / used black look

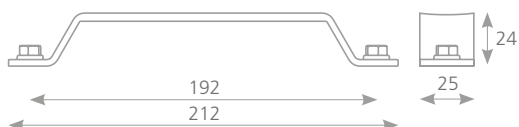

Kód / art.

202831

KENTUCKY DS

Černá ocel lesk / pewter



Kód / art.

202832

KENTUCKY DS

Černá ocel mat / matt old steel



Kód / art.

202843

RUSTIKÁLNÍ ÚCHYTKY

CLASSICAL HANDLES

KENTUCKY

Staročerná / used black look

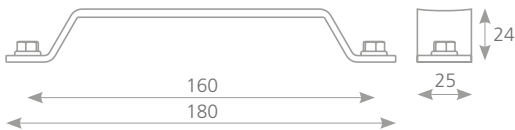

Kód / art.

202844

KENTUCKY

Černá ocel lesk / pewter

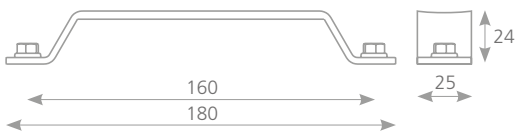

Kód / art.

202845

KENTUCKY

Černá ocel mat / matt old steel

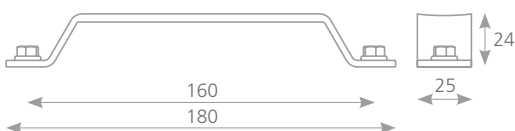

Kód / art.

202846

RUSTIKÁLNÍ ÚCHYTKY

CLASSICAL HANDLES

TORONTO DS

Staročerná / used black look

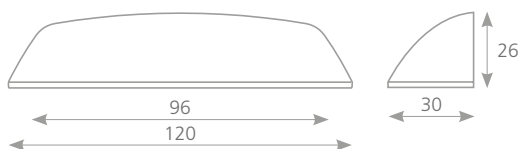

Kód / art.

202847

TORONTO DS

Černá ocel lesk / pewter

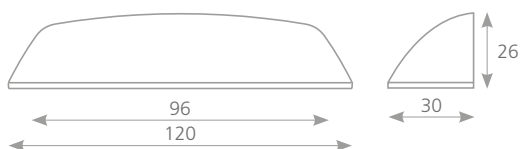

Kód / art.

202848

TORONTO DS

Černá ocel mat / matt old steel

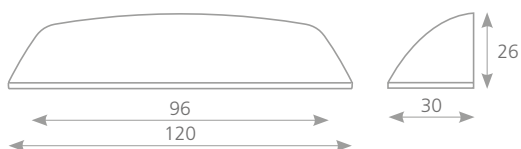

Kód / art.

202849

RUSTIKÁLNÍ ÚCHYTKY

CLASSICAL HANDLES

TORONTO

Staročerná / used black look

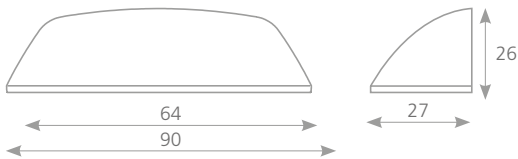

Kód / art.
202850

TORONTO

Černá ocel lesk / pewter

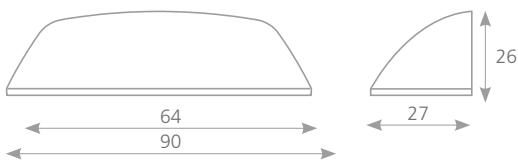

Kód / art.
202851

TORONTO

Černá ocel mat / matt old steel

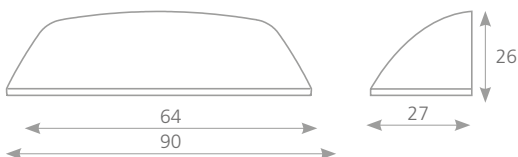

Kód / art.
202852

RUSTIKÁLNÍ ÚCHYTKY

CLASSICAL HANDLES

CORSICA

Staročerná / used black look

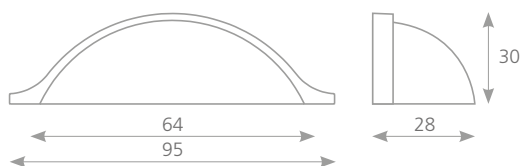

Kód / art.

202869

CORSICA

Černá ocel lesk / pewter

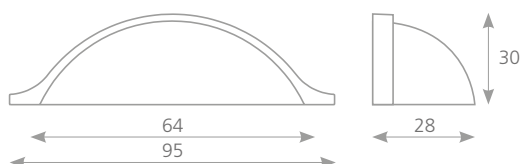

Kód / art.

202870

CORSICA

Černá ocel mat / matt old steel

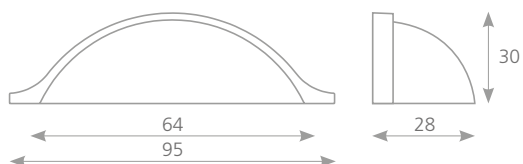

Kód / art.

202871



SHELL

Staročerná / used black look

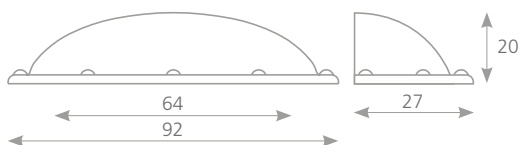

Kód / art.
202872

RUSTIKÁLNÍ ÚCHYTKY

CLASSICAL HANDLES

SHELL

Černá ocel lesk / pewter

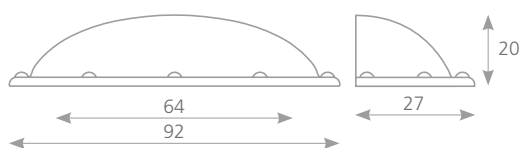

Kód / art.

202873

SHELL

Černá ocel mat / matt old steel

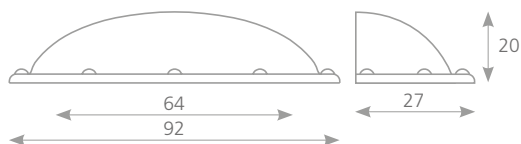

Kód / art.

202874

RUSTIKÁLNÍ ÚCHYTKY

CLASSICAL HANDLES

LINEA

Staročerná / used black look

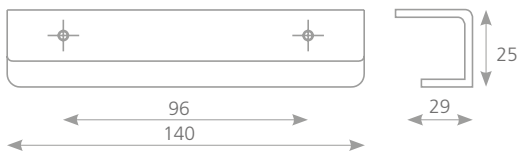

Kód / art.

204085

LINEA

Černá ocel lesk / pewter

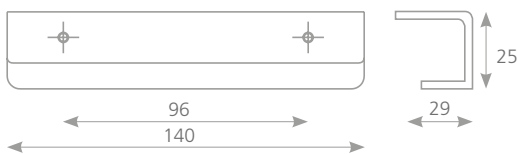

Kód / art.

204086

LINEA

Černá ocel mat / matt old steel

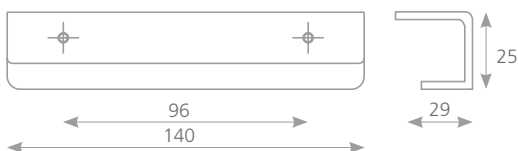

Kód / art.

204087

RUSTIKÁLNÍ ÚCHYTKY

CLASSICAL HANDLES

STAMP

Staročerná / used black look

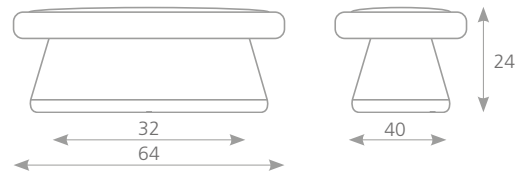

Kód / art.

204107

STAMP

Černá ocel lesk / pewter

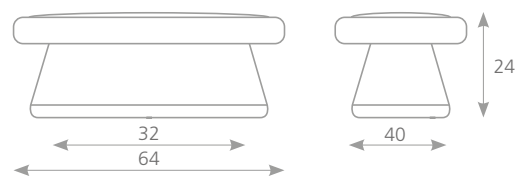

Kód / art.

204108

STAMP

Černá ocel mat / matt old steel

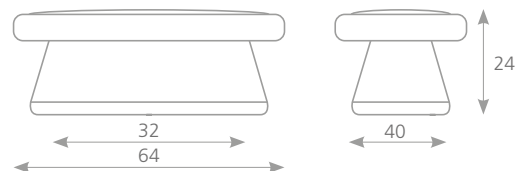

Kód / art.

204109

RUSTIKÁLNÍ ÚCHYTKY

CLASSICAL HANDLES

COTTAGE

Oxidovaná ocel / pewter

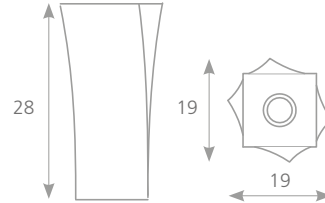

Kód / art.

42015

COTTAGE

Oxidovaná ocel / pewter



Kód / art.

C

L

42013

128

138

42011

160

170

TUVOLA

Černá ocel mat / black old steel

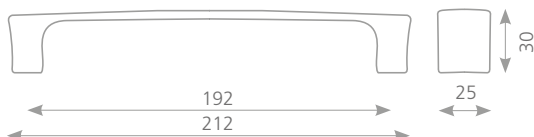

Kód / art.

267109 •

RUSTIKÁLNÍ ÚCHYTKY

CLASSICAL HANDLES

TUVOLA

Černá ocel mat / black old steel

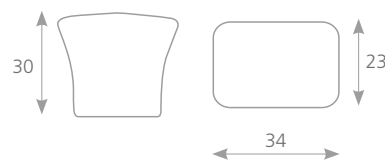

Kód / art.

267122 •

SERENA

Staroměď / old copper

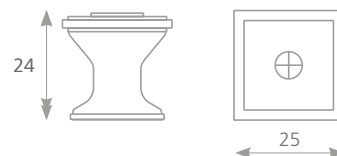

Kód / art.

157285

SERENA

Staroměď / old copper

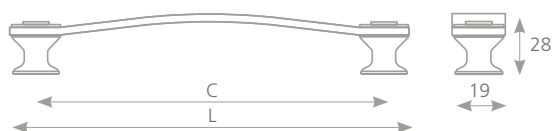

Kód / art.

C

L

157282

96

115

157283

128

147

157284

160

180

RUSTIKÁLNÍ ÚCHYTKY

CLASSICAL HANDLES

SERENA

Antik English / antique English

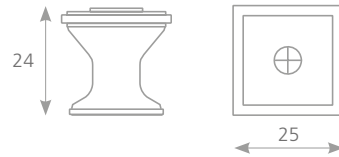

Kód / art.

203446

SERENA

Antik English / antique English

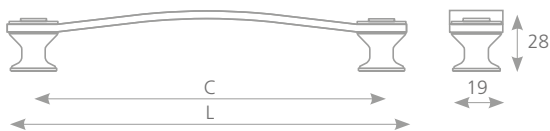

Kód / art.

C

L

203443

96

115

203444

128

147

203445

160

180

URICA

Staromosaz / old brass

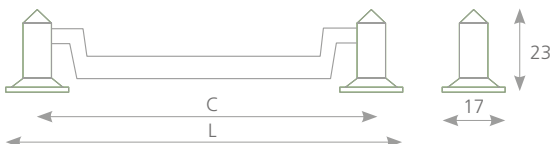

Kód / art.

C

L

09230

64

80

09253

96

110

RUSTIKÁLNÍ ÚCHYTKY

CLASSICAL HANDLES

VIRELLA

Tmavý kov / matt old steel

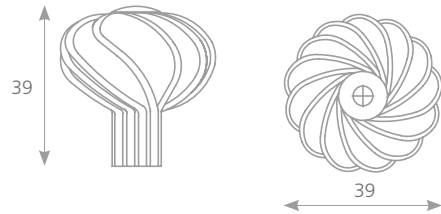

Kód / art.

157279

VIRELLA M

Tmavý kov / matt old steel

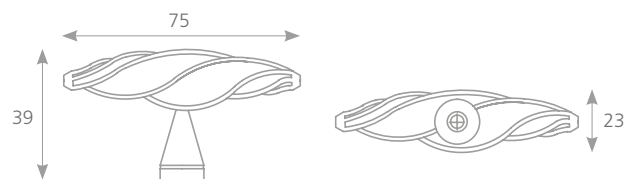

Kód / art.

157280

VIRELLA L

Tmavý kov / matt old steel

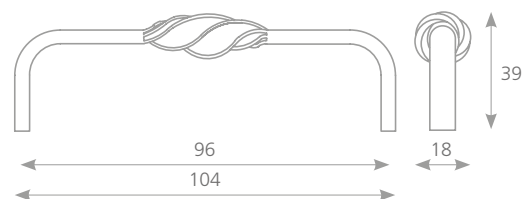

Kód / art.

157281



DORA

Starocín / old pewter



Kód / art.
226968

RUSTIKÁLNÍ ÚCHYTKY

CLASSICAL HANDLES

DORA

Staroměď / old copper



Kód / art.

226970

VALI

Starocín / old pewter



Kód / art.

C

L

226963

96

140

226964

128

172

226965

160

204

VALI

Staroměď / old copper



Kód / art.

C

L

226960

96

140

226961

128

172

226962

160

204

RUSTIKÁLNÍ ÚCHYTKY

CLASSICAL HANDLES

TOMO

Starocín / old pewter

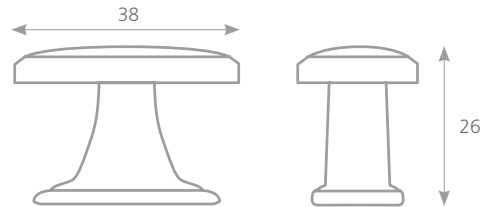

Kód / art.

226917

TOMO

Starocín / old pewter

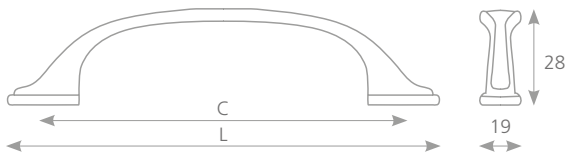

Kód / art.

C

L

226919

96

132

226921

160

196

TOMO

Staroměď / old copper

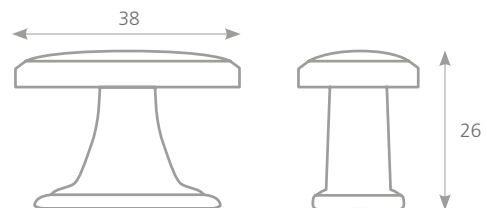

Kód / art.

226918



TOMO

Staroměď / old copper

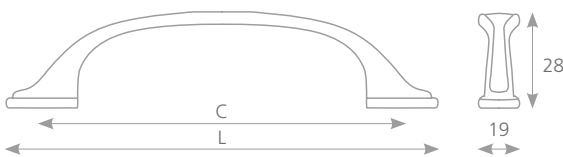

Kód / art.	C	L
226920	96	132
226922	160	196

RUSTIKÁLNÍ ÚCHYTKY

CLASSICAL HANDLES

HRAZDA 23

Staromosaz / old brass



Kód / art.	C	L
267383 •	96	115
267384 •	128	147
267385 •	160	179
252767 •	192	211
252768 •	256	275
267386 •	320	339

HRAZDA 23

Staré stříbro / old silver

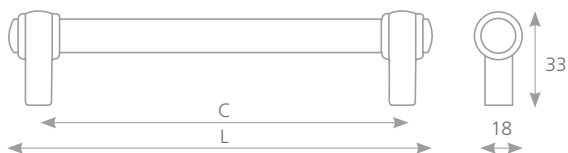

Kód / art.	C	L
267387 •	96	115
267388 •	128	147
267389 •	160	179
267390 •	192	211
267392 •	256	275
267393 •	320	339

• Na objednávku | On request

RUSTIKÁLNÍ ÚCHYTKY

CLASSICAL HANDLES

VICTORIA

Oxidovaná ocel / černá matná
Matt old steel / matt black

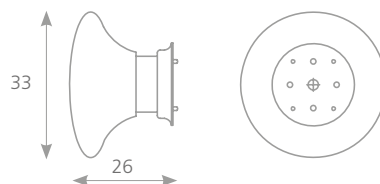

Kód / art.

42104

VICTORIA

Oxidovaná ocel / černá matná
Matt old steel / matt black

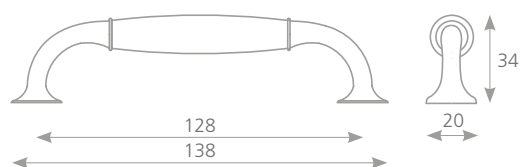

Kód / art.

42103

VICTORIA

Světlý bronz / patinovaný bronz
Light bronze / patinated bronze

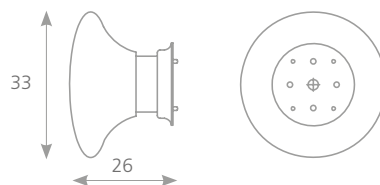

Kód / art.

157684

RUSTIKÁLNÍ ÚCHYTKY

CLASSICAL HANDLES

VICTORIA

Světlý bronz / patinovaný bronz
Light bronze / patinated bronze

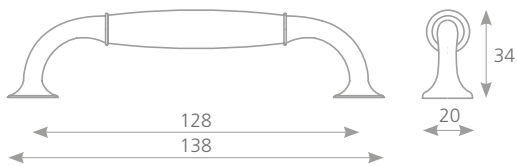

Kód / art.

157685

CARAT

Tmavý bronz / porcelán krémový
Dark bronze / creme porcelain

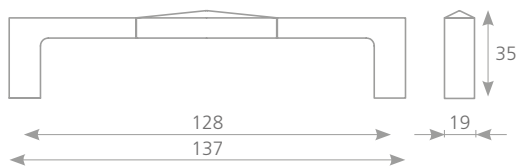
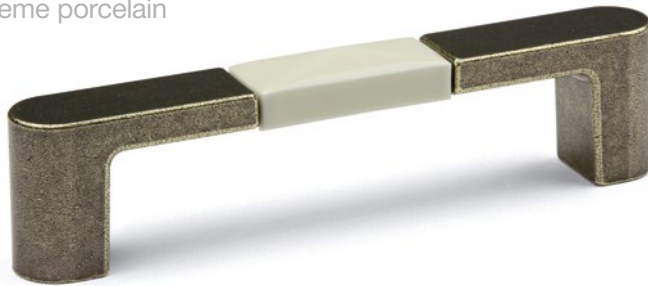

Kód / art.

42105

ULIKO

Staromosaz / old brass



Kód / art.

157265

157266

C

96

128

L

141

173

RUSTIKÁLNÍ ÚCHYTKY

CLASSICAL HANDLES

COUNTRY

Tmavý bronz / popraskaný porcelán
Dark bronze / crackled porcelain

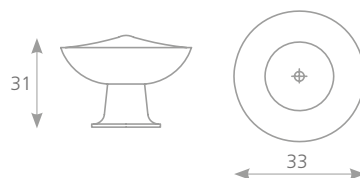

Kód / art.

42102

COUNTRY

Oxidovaná ocel / popraskaný porcelán
Pewter / crackled porcelain

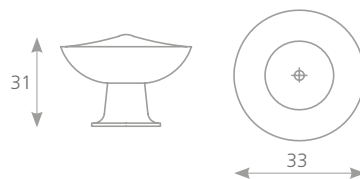

Kód / art.

15766

COUNTRY

Jasný bronz / popraskaný porcelán
Light bronze / crackled porcelain

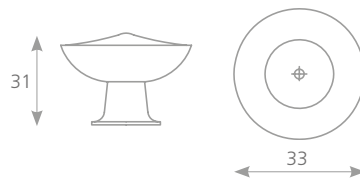

Kód / art.

15769

RUSTIKÁLNÍ ÚCHYTKY

CLASSICAL HANDLES

COUNTRY

Tmavý bronz / popraskaný porcelán
Dark bronze / crackled porcelain

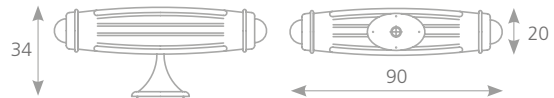

Kód / art.

42101

COUNTRY

Oxidovaná ocel / popraskaný porcelán
Pewter / crackled porcelain

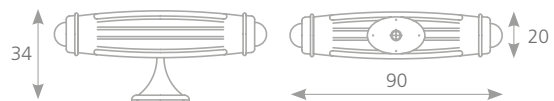

Kód / art.

15767

COUNTRY

Tmavý bronz / popraskaný porcelán
Dark bronze / crackled porcelain

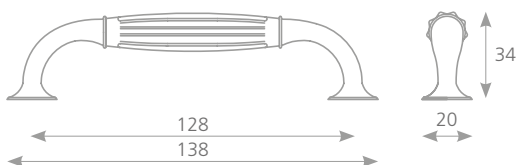

Kód / art.

42100

RUSTIKÁLNÍ ÚCHYTKY

CLASSICAL HANDLES

COUNTRY

Oxidovaná ocel / popraskaný porcelán
Pewter / crackled porcelain

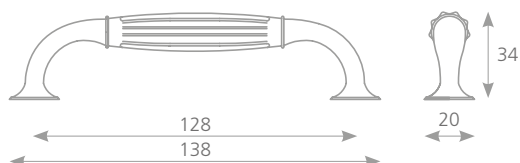

Kód / art.

157678

COUNTRY

Jasný bronz / popraskaný porcelán
Light bronze / crackled porcelain

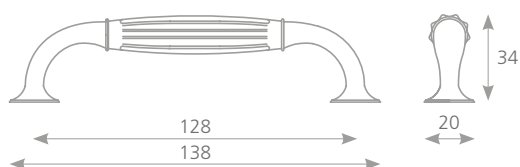

Kód / art.

157681

GIPA

Staromosaz / bílý porcelán
Old brass / white porcelain

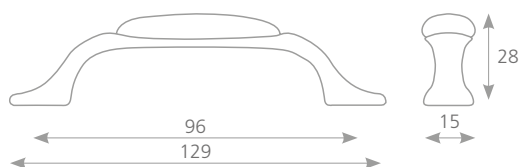

Kód / art.

09240

RUSTIKÁLNÍ ÚCHYTKY

CLASSICAL HANDLES

GIPA

Staromosaz / popraskaný porcelán
Old brass / crackled porcelain

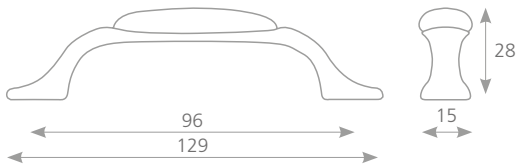

Kód / art.

09229

GIPA

Nikl patina / popraskaný porcelán
Nickel patinated / crackled porcelain

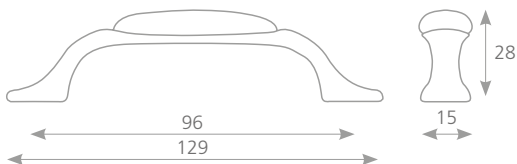

Kód / art.

09265

GIPA

Staromosaz / porcelán motiv
Old brass / porcelain motif

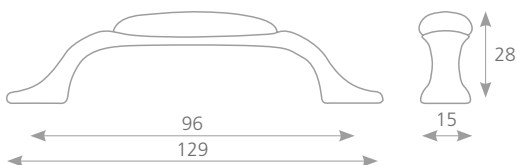

Kód / art.

228270

RUSTIKÁLNÍ ÚCHYTKY

CLASSICAL HANDLES

GIPA

Níkl patina / bílý porcelán
Patinated nickel / white porcelain

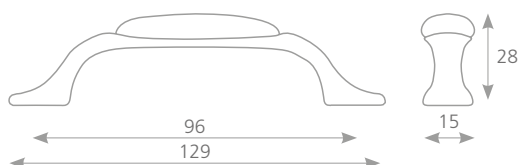

Kód / art.

09243

GIPA

Staromosaz / porcelán motiv
Old brass / porcelain motif



Kód / art.

09226

GIPA

Staromosaz / bílý porcelán
Old brass / white porcelain

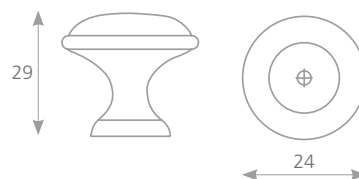

Kód / art.

09210



GIPA

Staromosaz / porcelán motiv

Old brass / porcelain motif

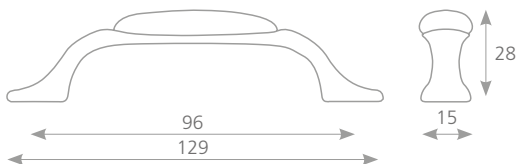

Kód / art.
09239

RUSTIKÁLNÍ ÚCHYTKY

CLASSICAL HANDLES

GIPA

Staromosaz / popraskaný porcelán

Old brass / crackled porcelain

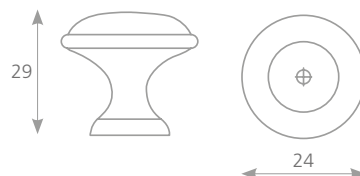

Kód / art.

09220

GIPA

Nikl patina / bílý porcelán

Patinated nickel / white porcelain

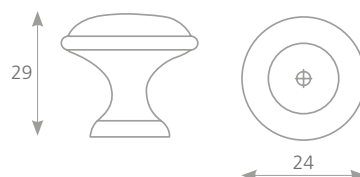

Kód / art.

09211

GIPA

Nikl patina / popraskaný porcelán

Patinated nickel / crackled porcelain

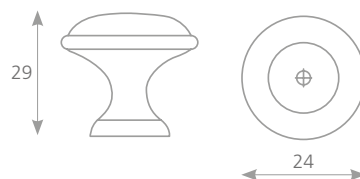

Kód / art.

09221

RUSTIKÁLNÍ ÚCHYTKY

CLASSICAL HANDLES

GIPA

Staromosaz / porcelán motiv
Old brass / porcelain motif

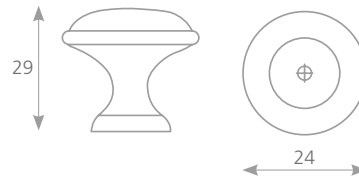

Kód / art.

228272

SARA

Staromosaz / bílý porcelán
Old brass / white porcelain

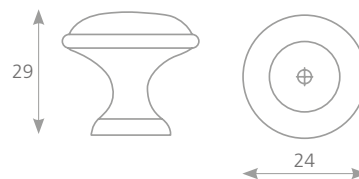

Kód / art.

07649

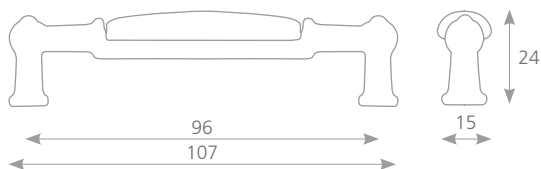

SARA

Staromosaz / popraskaný porcelán
Old brass / crackled porcelain



Kód / art.

228332

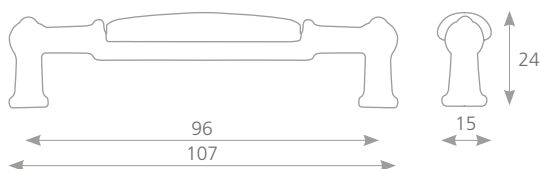

RUSTIKÁLNÍ ÚCHYTKY

CLASSICAL HANDLES

TECA

Bílý porcelán / white porcelain

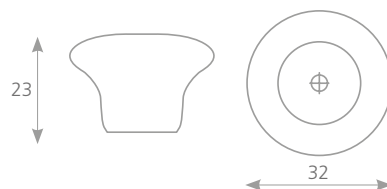

Kód / art.

228333

TECA

Popraskaný porcelán / crackled porcelain

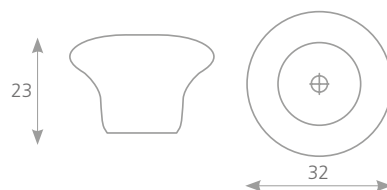

Kód / art.

228334

STOCKHOLM

Tmavý bronz (patina) / dark bronze

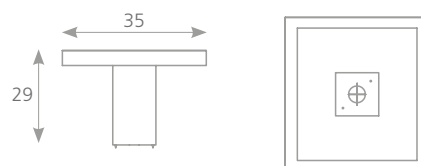

Kód / art.

157660

RUSTIKÁLNÍ ÚCHYTKY

CLASSICAL HANDLES

STOCKHOLM

Světlý bronz / light bronze

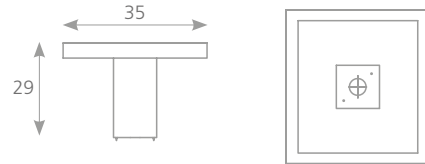
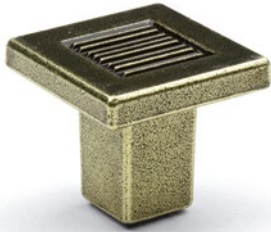

Kód / art.

157662

STOCKHOLM

Oxidovaná ocel / pewter

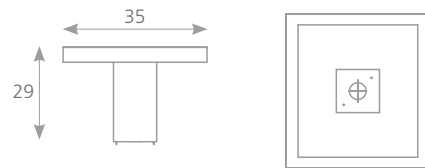

Kód / art.

157661

STOCKHOLM

Tmavý bronz (patina) / dark bronze

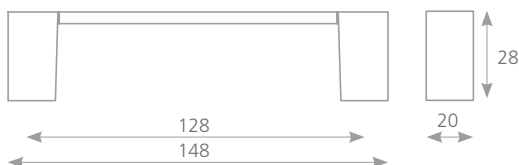

Kód / art.

157663

RUSTIKÁLNÍ ÚCHYTKY

CLASSICAL HANDLES

STOCKHOLM

Světlý bronz / light bronze

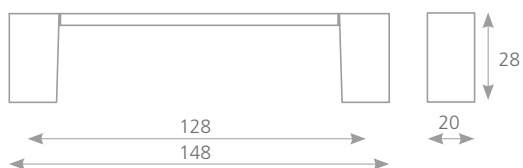
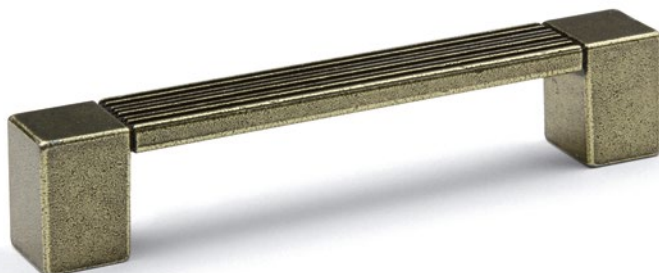

Kód / art.

157665

STOCKHOLM

Oxidovaná ocel / pewter



Kód / art.

157664



Dřevěné úchytky
Wooden handles



DŘEVĚNÉ ÚCHYTKY

WOODEN HANDLES

BALA

Barvené dřevo / painted wood

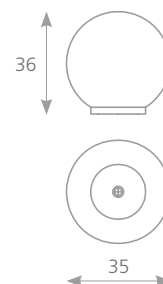

Modrá / blue	Červená / red	Růžová / pink	Oranžová / orange	Fialová / violet	Zelená / green	Olivová / olive
09497	09489	09490	158702	09491	09492	09493

MUNA

Barvené dřevo / painted wood

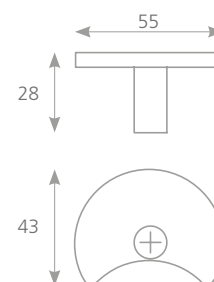

Žlutá / yellow	Modrá / blue	Růžová / pink	Oranžová / orange	Fialová / violet	Červená / red	Olivová / olive
158710	158711	158712	158713	158714	158715	158716

SOLA

Barvené dřevo / painted wood

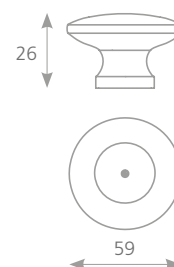

Modrá / blue	Červená / red	Růžová / pink	Oranžová / orange	Zelená / green	Olivová / olive	Žlutá / yellow
158717	158718	158719	158720	158721	158722	158723

DŘEVĚNÉ ÚCHYTKY

WOODEN HANDLES

JACEK

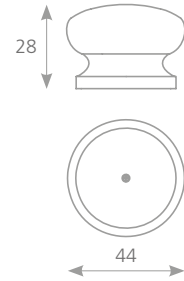

Dub lak / oak

Borovice lak / pine

Buk lak / beech

Ořešak lak / alder

Borovice surová / pine

Buk surový / beech

09401

09402

09403

09404

158698

158699

ADAM

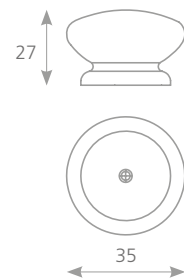

Dub lak / oak

Borovice lak / pine

Buk lak / beech

Ořešak lak / alder

Borovice surová / pine

Buk surový / beech

09409

09410

09411

09412

158703

158704

OLZA

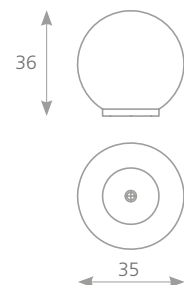

Borovice lak / pine

Buk lak / beech

Borovice surová / pine

Buk surový / beech

09406

09407

158700

158701

DŘEVĚNÉ ÚCHYTKY

WOODEN HANDLES

JURA

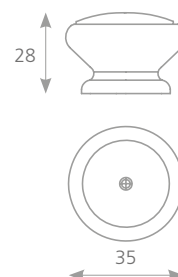

Dub lak / oak

09413

Borovice lak / pine

09414

Buk lak / beech

09415

Olše lak / alder

09416

MATRA

Dub lak / oak

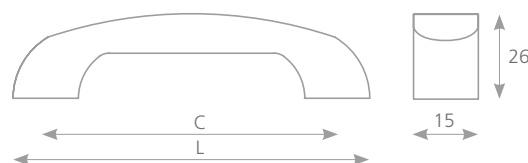

Kód / art.

C

L

09430

96

112

09434

128

144

MATRA

Borovice lak / pine

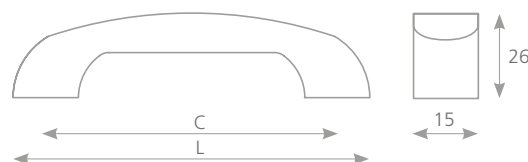

Kód / art.

C

L

09431

96

112

09435

128

144

DŘEVĚNÉ ÚCHYTKY

WOODEN HANDLES

MATRA

Buk lak / beech

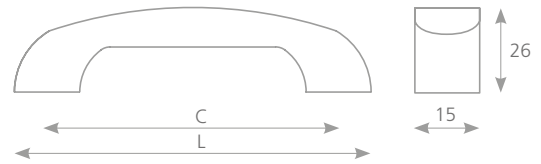

Kód / art.	C	L
09432	96	112
09436	128	144

MATRA

Olše lak / alder

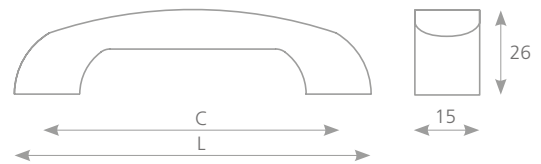

Kód / art.	C	L
09433	96	112
09437	128	144

BERGA

Borovice lak / pine



Kód / art.
09460

DŘEVĚNÉ ÚCHYTKY

WOODEN HANDLES

BERGA

Buk lak / beech



Kód / art.

09461

BERGA

Olše lak / alder



Kód / art.

09462



BERGA

Dub lak / oak

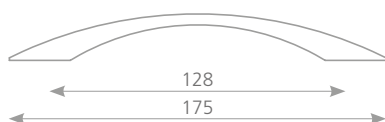

Kód / art.
09459

www.tulip-design.com

DŘEVĚNÉ ÚCHYTKY

WOODEN HANDLES

PIERA

Buk / satin chrom
Beech / matt chrome



Kód / art.	C	L
37820	96	125
37821	128	157
37822	160	189

FILA

Buk / satin chrom
Beech / matt chrome

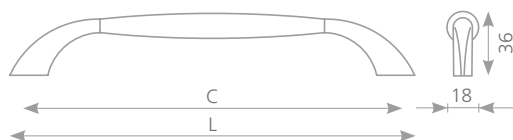

Kód / art.	C	L
37823	96	130
37824	128	162
37825	160	194



Plastové úchytky
Plastic handles

PLASTOVÉ ÚCHYTKY

PLASTIC HANDLES

P435

Bílá / white

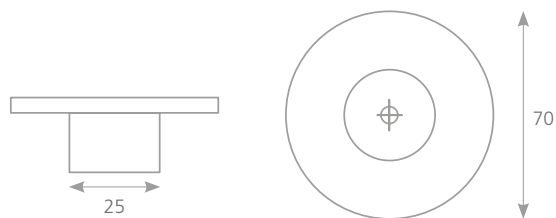

Kód / art.

265486

P435

Oranžová / orange

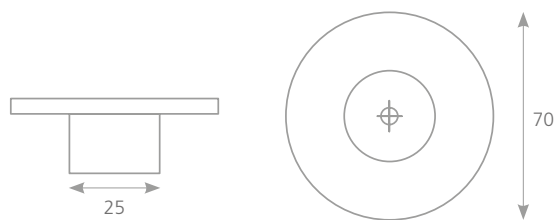

Kód / art.

265487

P435

Zelená / green

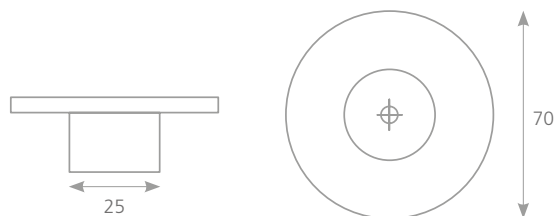

Kód / art.

265488

PLASTOVÉ ÚCHYTKY

PLASTIC HANDLES

P431

Bílá / white

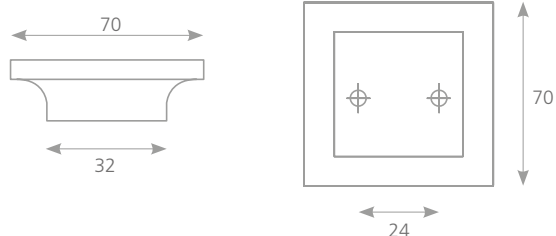

Kód / art.

265483

P431

Oranžová / orange

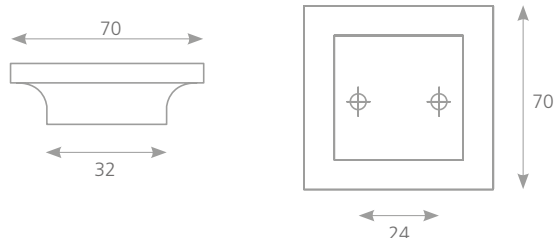

Kód / art.

265484

P431

Zelená / green

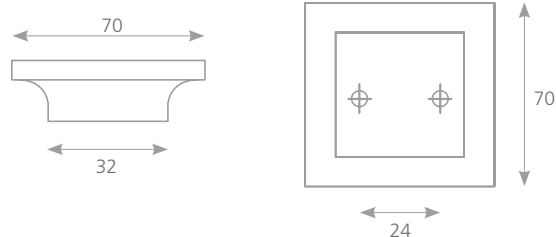

Kód / art.

265485

PLASTOVÉ ÚCHYTKY

PLASTIC HANDLES

P603

Bílá / white

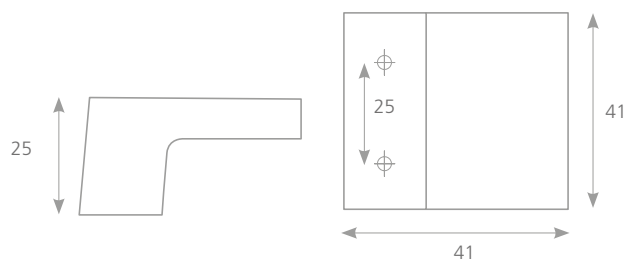

Kód / art.

265471

P603

Černá / black

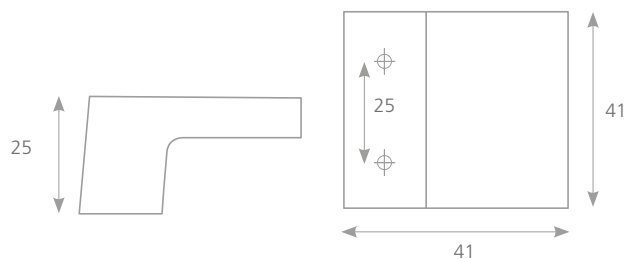

Kód / art.

265473

P603

Šedá / grey

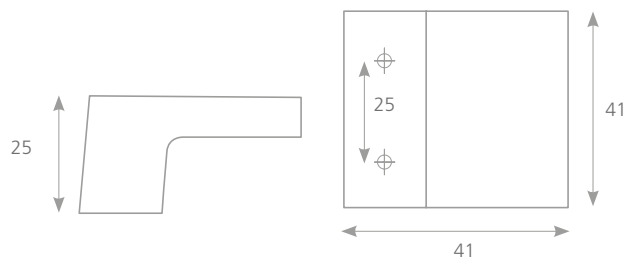

Kód / art.

265474

PLASTOVÉ ÚCHYTKY

PLASTIC HANDLES

P603

Běžová / beige

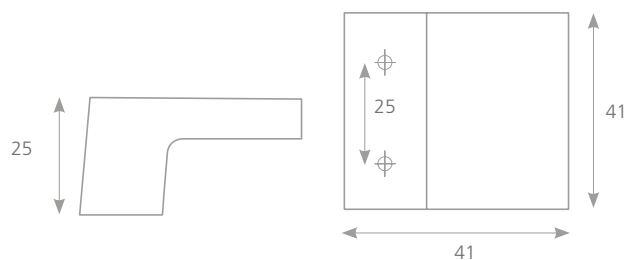

Kód / art.

265475

M306

Bílá / white

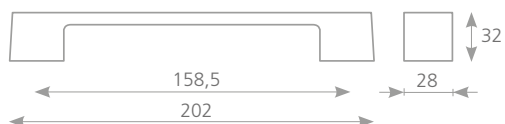

Kód / art.

265479

M306

Černá / black

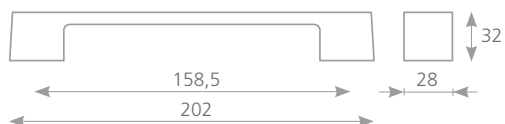

Kód / art.

265480

PLASTOVÉ ÚCHYTKY

PLASTIC HANDLES

M306

Šedá / grey

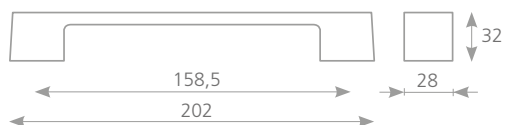

Kód / art.

265481

M306

Běžová / beige

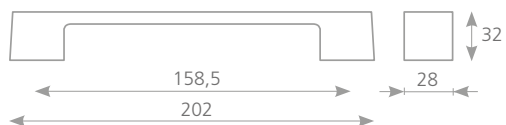

Kód / art.

265482



FIORA

Měkčený plast / softened plastic

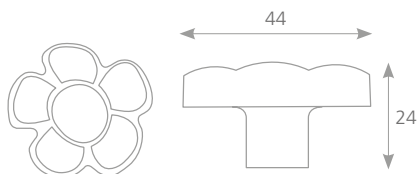

Kód / art.
222116

www.tulip-design.com

PLASTOVÉ ÚCHYTKY

PLASTIC HANDLES

FIORA

Měkčený plast
Softened plastic

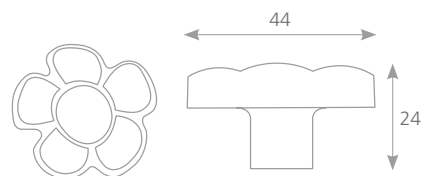

Kód / art.

222117

FIORA

Měkčený plast
Softened plastic

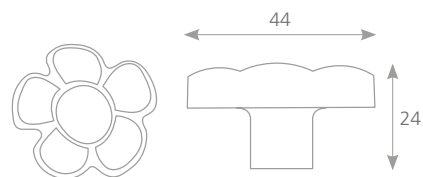

Kód / art.

152866

PIAZZA

Měkčený plast
Softened plastic

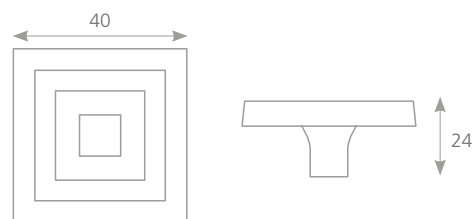

Kód / art.

171121



PALLA

Měkčený plast / softened plastic



38

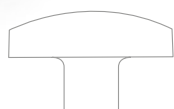

25

Kód / art.
198702

PLASTOVÉ ÚCHYTKY

PLASTIC HANDLES

STELLA

Měkčený plast
Softened plastic

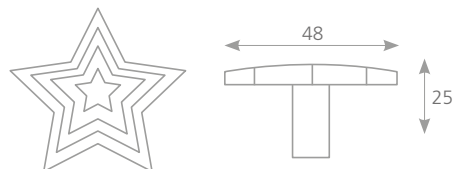
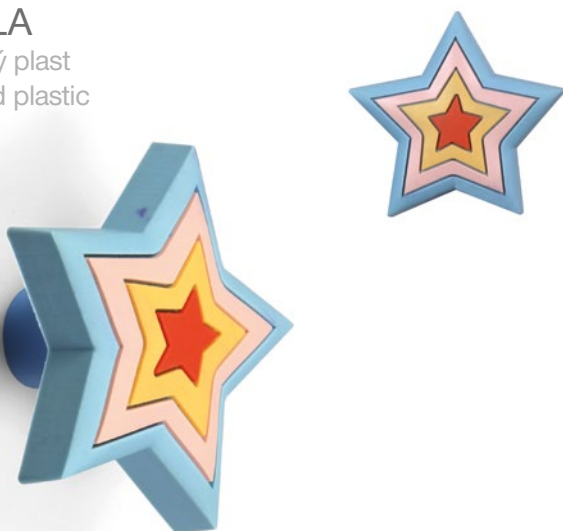

Kód / art.

231462

FISK

Měkčený plast
Softened plastic

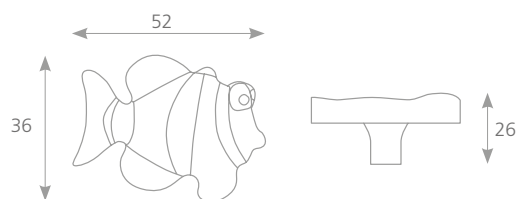
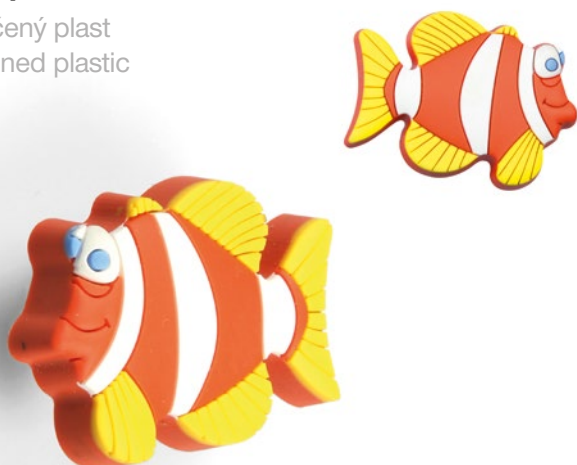

Kód / art.

101074

CHAT

Měkčený plast
Softened plastic

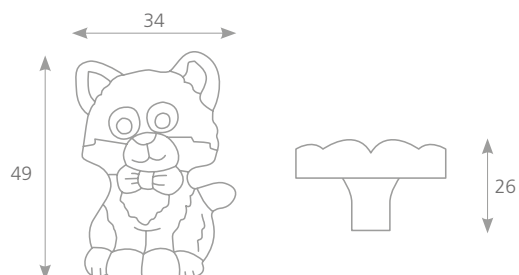

Kód / art.

198703

PLASTOVÉ ÚCHYTKY

PLASTIC HANDLES

RANA

Měkkčený plast
Softened plastic

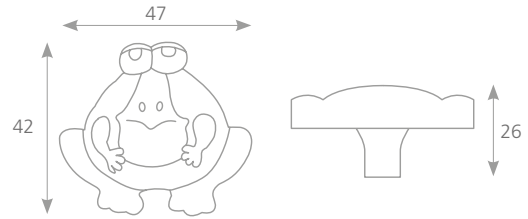

Kód / art.

198704

PERCHA I

Tvrzený plast
Hardened plastic

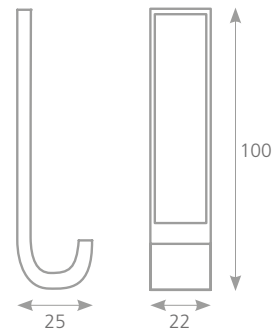

Kód / art.

231454

PERCHA

Tvrzený plast
Hardened plastic

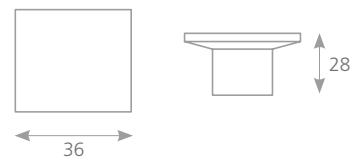

Kód / art.

231469

PLASTOVÉ ÚCHYTKY

PLASTIC HANDLES

PERCHA IV

Tvrzený plast
Hardened plastic

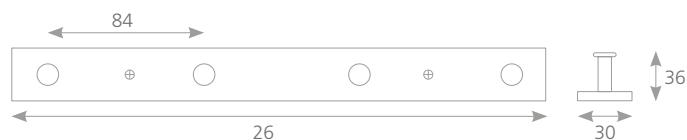

Kód / art.

231455

PERCHA II

Tvrzený plast
Hardened plastic

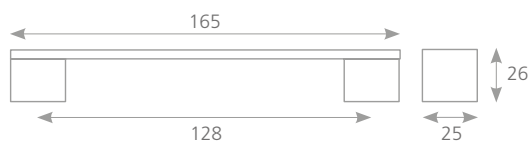

Kód / art.

231456

PLASTOVÉ ÚCHYTKY

PLASTIC HANDLES

TREN I

Tvrzený plast
Hardened plastic

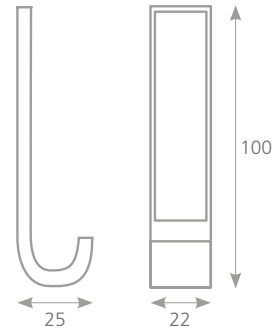

Kód / art.

231458

TREN

Tvrzený plast
Hardened plastic

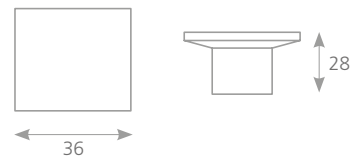

Kód / art.

231459

PLASTOVÉ ÚCHYTKY

PLASTIC HANDLES

TREN IV

Tvrzený plast
Hardened plastic

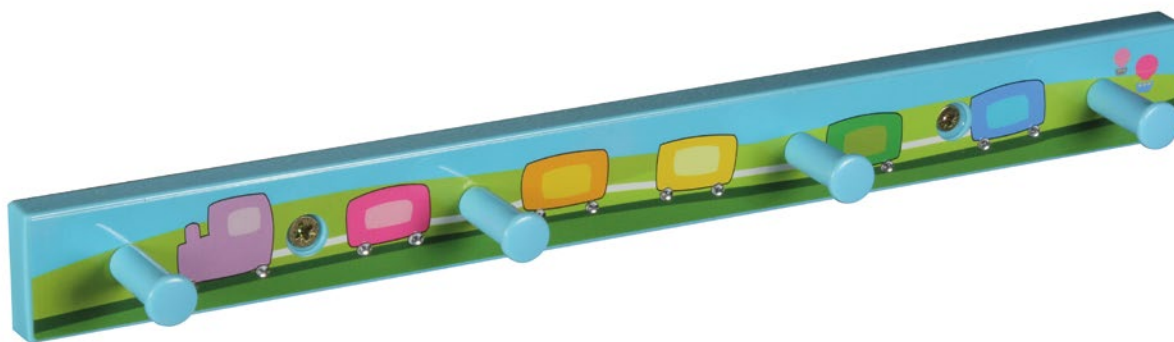

Kód / art.

231470

TREN II

Tvrzený plast
Hardened plastic

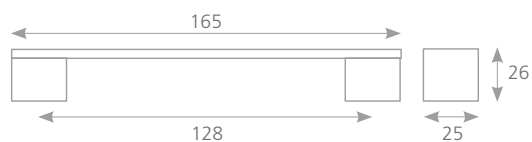
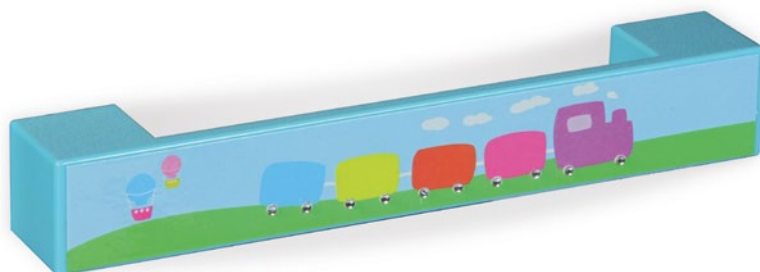

Kód / art.

231460



Věšáky
Furniture hooks



VĚŠÁKY

FURNITURE HOOKS

DONA

Chrom / polished chrome

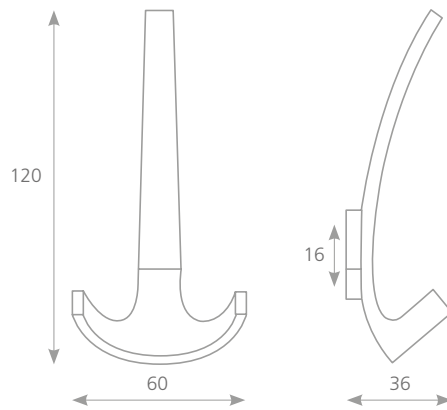

Kód / art.

202855

DONA

Satin chrom / matt chrome

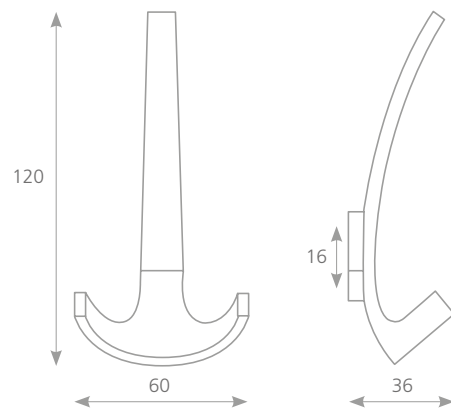

Kód / art.

202856

DONA

Nikl matný / matt nickel

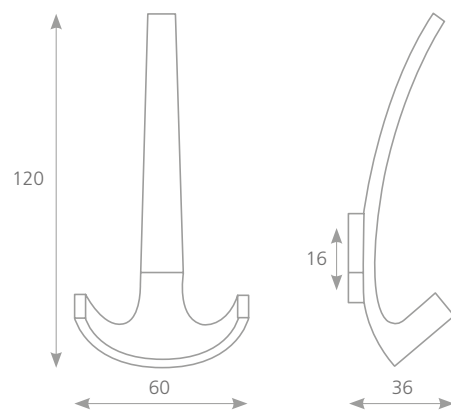

Kód / art.

202857

BELLUNA

Satin chrom / matt chrome

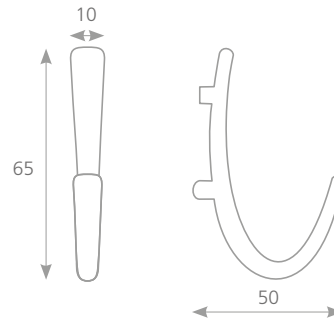

Kód / art.

157321

BELLUNA

Chrom / polished chrome

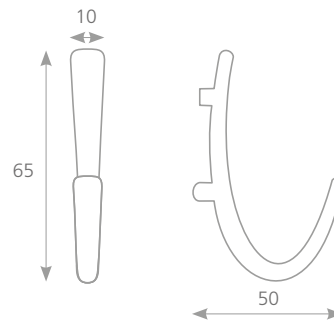

Kód / art.

157323

BELLUNA

Broušený nikel / nickel brushed

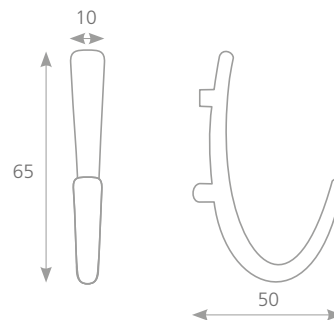

Kód / art.

157322

VĚŠÁKY

FURNITURE HOOKS

BELLUNA XL

Satin chrom / matt chrome

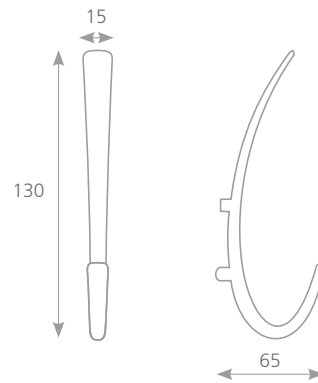

Kód / art.

157324

BELLUNA XL

Chrom / polished chrome

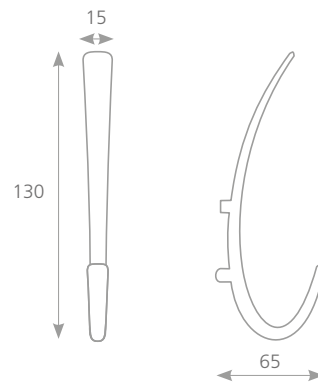

Kód / art.

157326

BELLUNA XL

Broušený nikl / nickel brushed

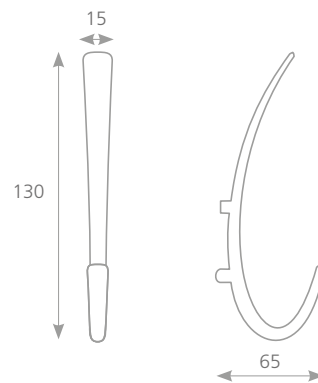

Kód / art.

157325

HONZA XL

Imitace nerezí
Stainless steel imitation

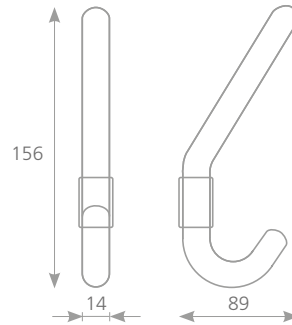

Kód / art.

10463

HONZA XL

Chrom matný / matt chrome

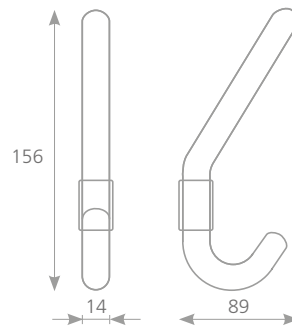

Kód / art.

10465

HONZA

Imitace nerezí / stainless steel imitation

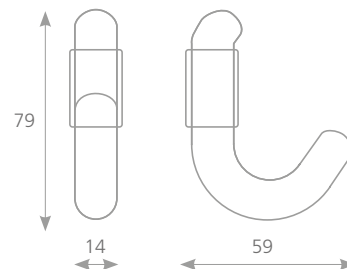

Kód / art.

10460

VĚŠÁKY

FURNITURE HOOKS

HONZA

Chrom matný / matt chrome

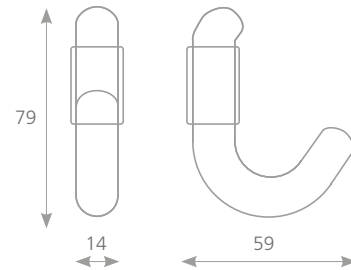

Kód / art.

10462

IWO

Satin nikl / matt nickel

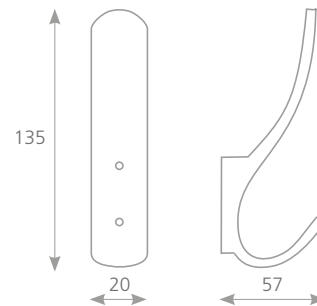

Kód / art.

08889

IWO

Satin chrom / matt chrome

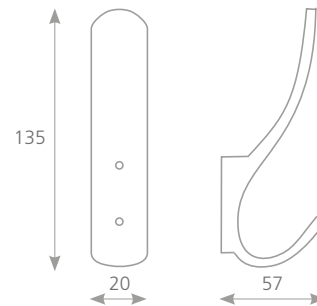

Kód / art.

08890

ERIC

Chrom lesklý / polished chrome

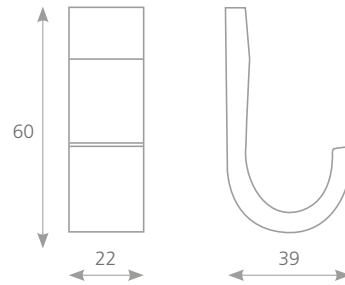

Kód / art.

202930

ERIC

Satin nikl / matt nickel



Kód / art.

202931

ERIC

Broušený nikl / nickel brushed

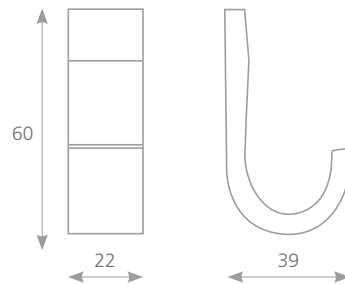

Kód / art.

202932

VĚŠÁKY

FURNITURE HOOKS

ERIC

Satin chrom / matt chrome

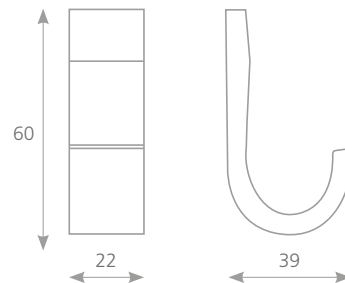

Kód / art.

202933



PERA

Stříbrná / silver

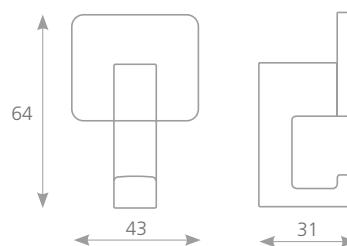

Kód / art.

77812



PERA

Satin nikl / matt nickel

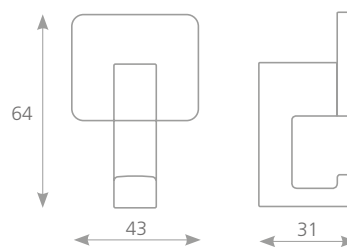

Kód / art.

77813



ROSA

Stříbrná / silver

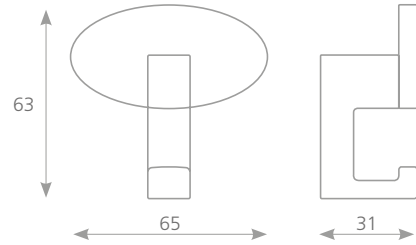

Kód / art.

77811

ROSA

Satin nikel / matt nickel

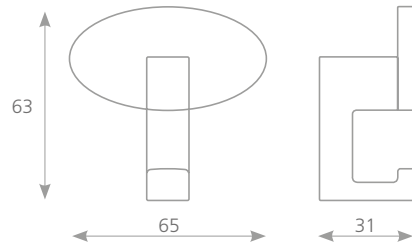

Kód / art.

77810

VICTORY

Stříbrná / silver

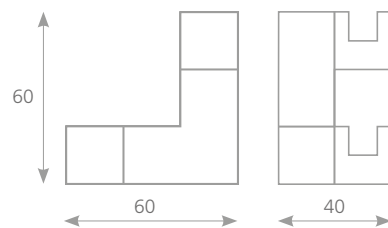
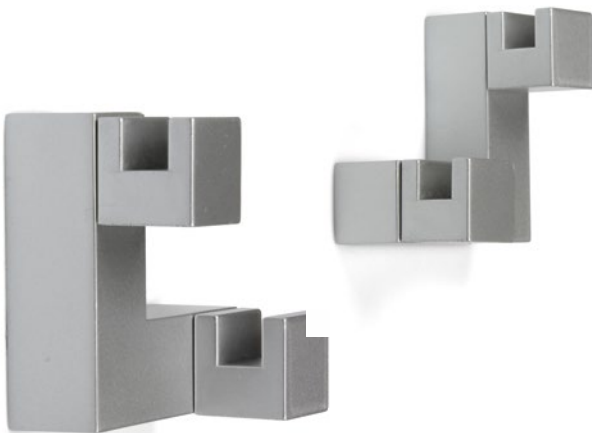

Kód / art.

77827

VĚŠÁKY

FURNITURE HOOKS

VICTORY

Satin nikel / matt nickel

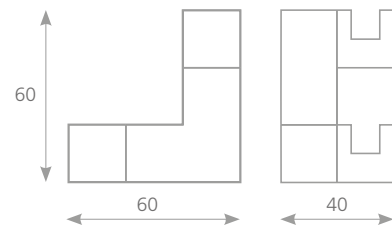

Kód / art.

77828

FRANCA

Satin chrom / matt chrome

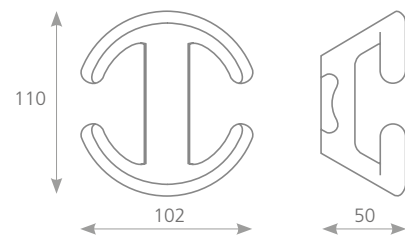

Kód / art.

77814

FRANCA

Stříbrná / silver

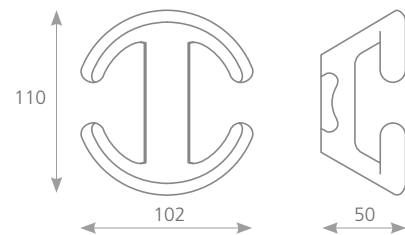

Kód / art.

77815

FRANCA

Oliva / olive

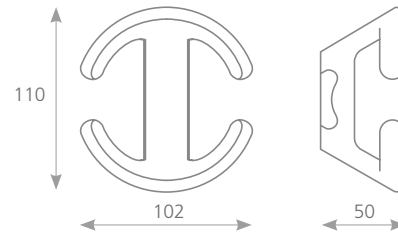

Kód / art.

77816



DORIS

Chrom lesklý / polished chrome

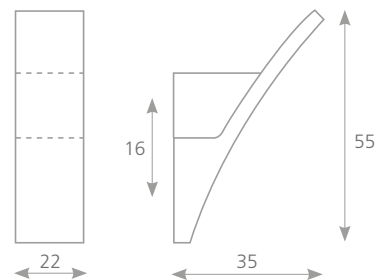

Kód / art.

204686



DORIS

Chrom matný / matt chrome

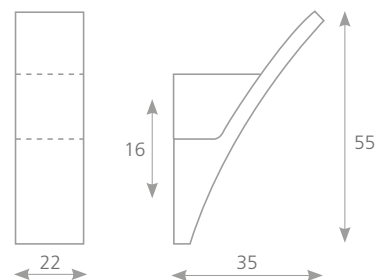

Kód / art.

204687



VĚŠÁKY

FURNITURE HOOKS

DORIS

Nikl matný / matt nickel

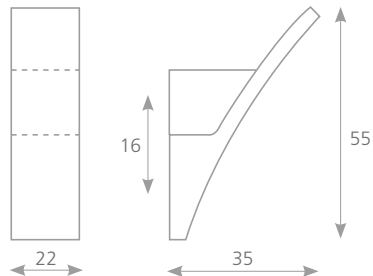

Kód / art.

204688



DYAN

Satin nikl
Matt nickel

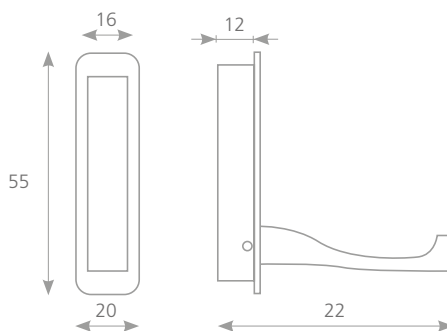

Kód / art.

231588



DYAN

Satin chrom
Matt chrome

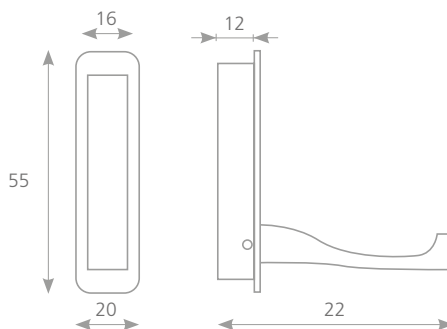

Kód / art.

231589



VĚŠÁKY

FURNITURE HOOKS

DYAN

Chrom lesklý
Polished chrome

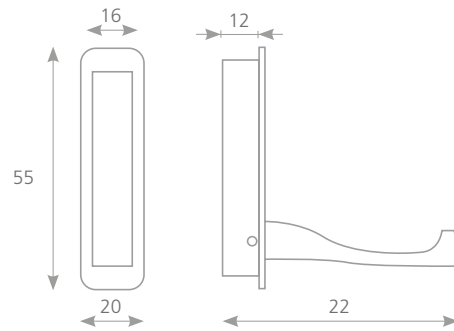

Kód / art.
231590

ROTOLO

Stříbrná / silver

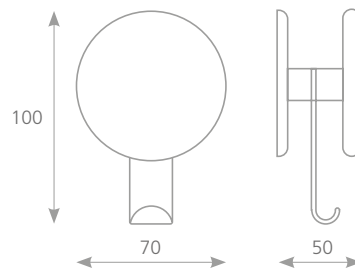

Kód / art.
77802

TARASA

Stříbrná / silver

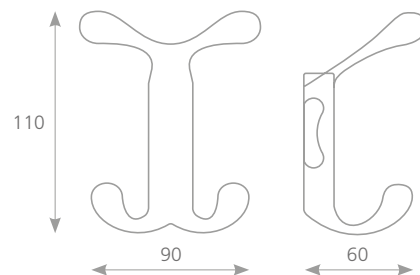

Kód / art.
77806

VĚŠÁKY

FURNITURE HOOKS

TARASA

Satin nikl / matt nickel

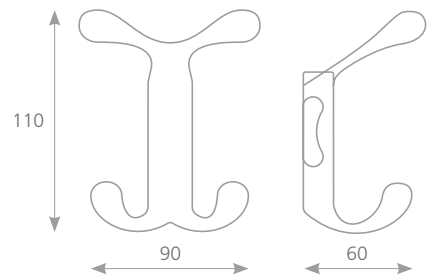

Kód / art.

77807



ROBERTO

Stříbrná / silver

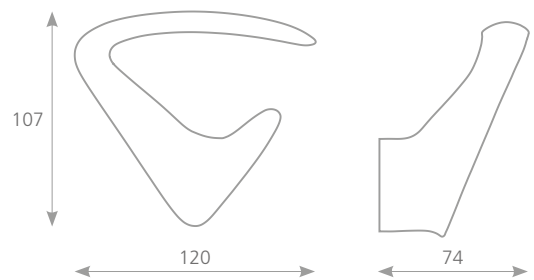

Kód / art.

77818



ROBERTO

Satin nikl / matt nickel

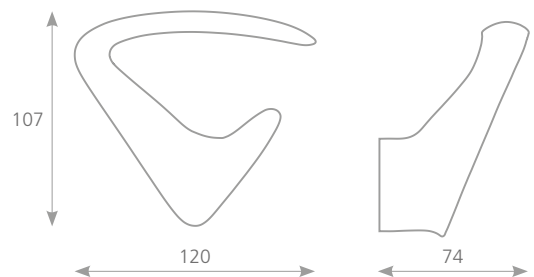

Kód / art.

77819



MELA

Stříbrná / silver

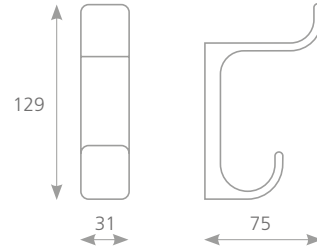

Kód / art.

77800

ROKOS

Satin nikel / matt nickel

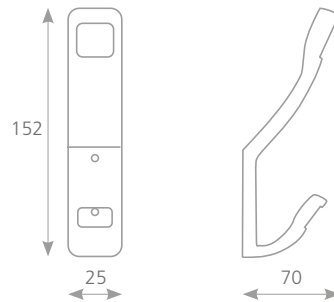

Kód / art.

224254

ROKOS

Satin chrom / matt chrome

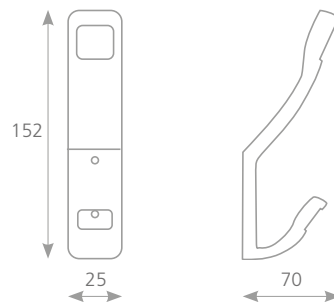

Kód / art.

224255

VĚŠÁKY

FURNITURE HOOKS

DAX

Satin chrom / matt chrome

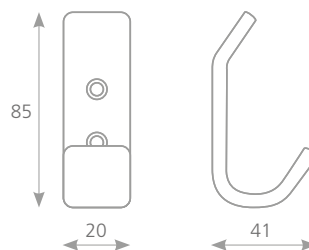

Kód / art.

157327



DAX

Chrom / polished chrome

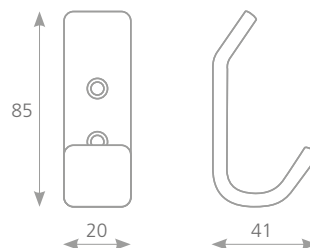

Kód / art.

157329



DAX

Satin nikl / matt nickel

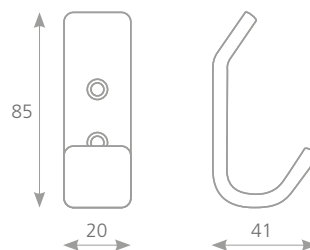

Kód / art.

157328



WA 01

Hliník / Aluminium

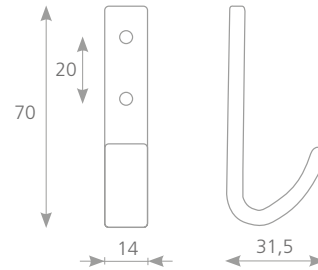

Kód / art.

08809

TELUS

Satin nikl / matt nickel

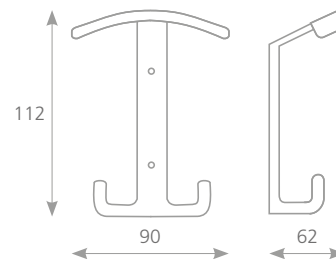

Kód / art.

08958

TELUS

Satin chrom / matt chrome

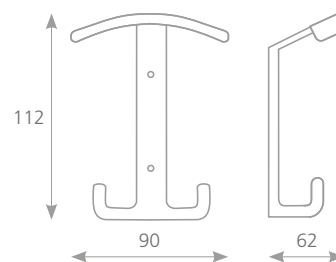

Kód / art.

08959

VĚŠÁKY

FURNITURE HOOKS

TELUS

Chrom / polished chrome

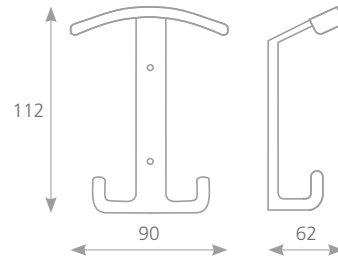

Kód / art.

08957



ILAN

Satin nikl / matt nickel

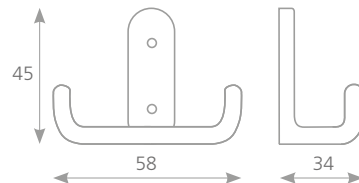

Kód / art.

08952



ILAN

Satin chrom / matt chrome

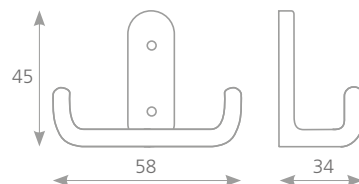

Kód / art.

08953



ILAN

Chrom / polished chrome

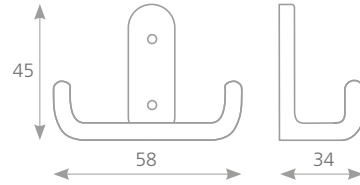

Kód / art.

08951

LUGO

Satin nikl / matt nickel

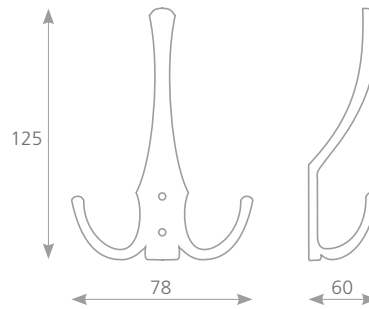

Kód / art.

35581

LUGO

Satin chrom / matt chrome

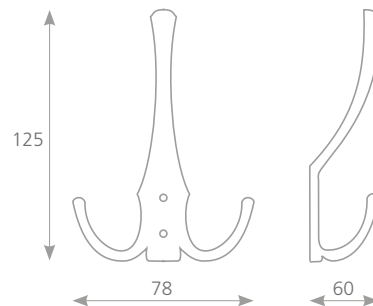

Kód / art.

35582

VĚŠÁKY

FURNITURE HOOKS

LUGO

Chrom / polished chrome

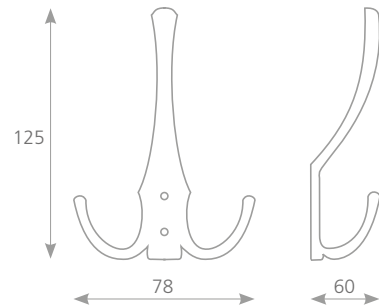

Kód / art.
35583



LUGO

Mosaz / brass

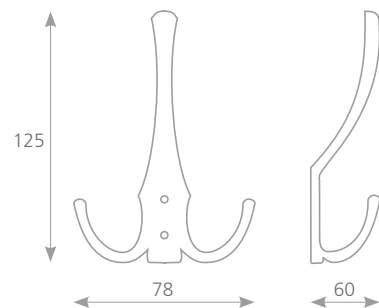

Kód / art.
35584



LUGO

Černá / black

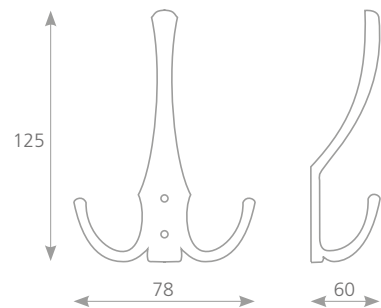

Kód / art.
35585



DAVOS

Satin nikel / matt nickel

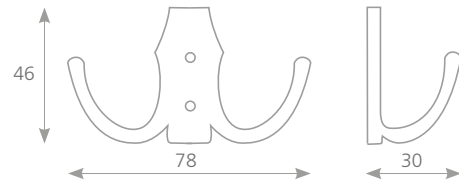

Kód / art.

35591

DAVOS

Satin chrom / matt chrome

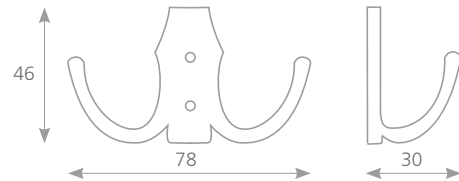

Kód / art.

35592

DAVOS

Chrom / polished chrome

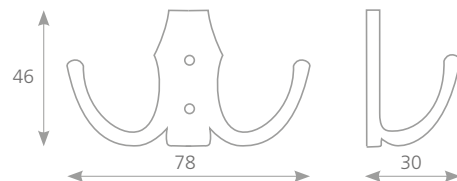

Kód / art.

35593

VĚŠÁKY

FURNITURE HOOKS

DAVOS
Mosaz / brass

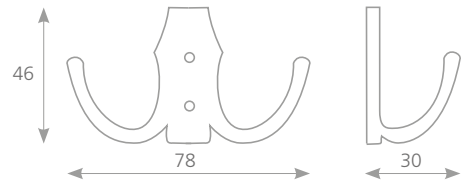

Kód / art.
35594



DAVOS
Černá / black

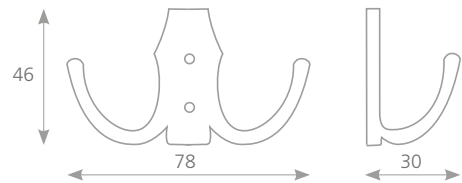

Kód / art.
35595



PETROS
Starocín / old pewter

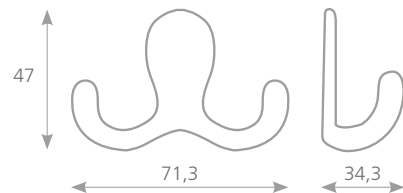

Kód / art.
226990





PETROS

Staroměď / old copper

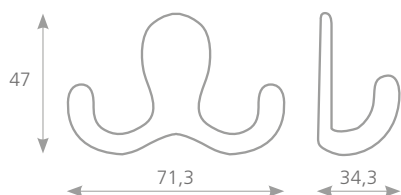

Kód / art.
226989

www.tulip-design.com

VĚŠÁKY

FURNITURE HOOKS

PETROS

Satin chrom / matt chrome

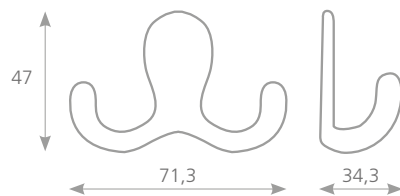

Kód / art.

226991



PETROS

Chrom / chrome

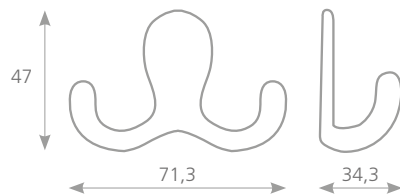

Kód / art.

226992



CARLOS

Satin chrom
Matt chrome

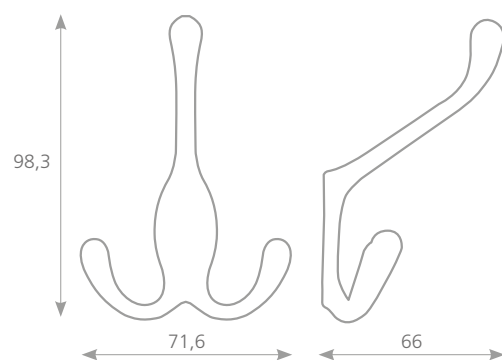

Kód / art.

226993



CARLOS

Chrom lesklý
Polished chrome

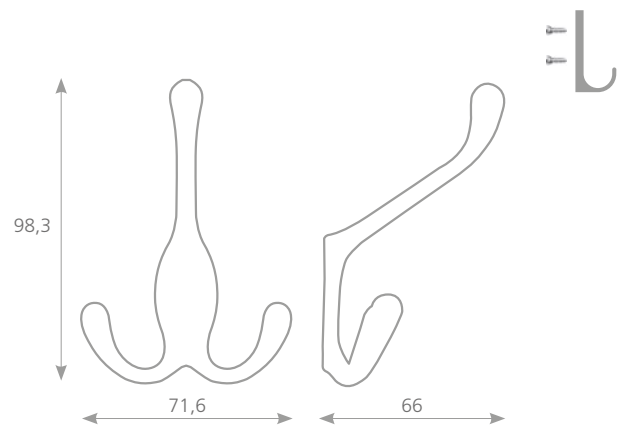

Kód / art.
226994

CARLOS

Starocín
Old pewter

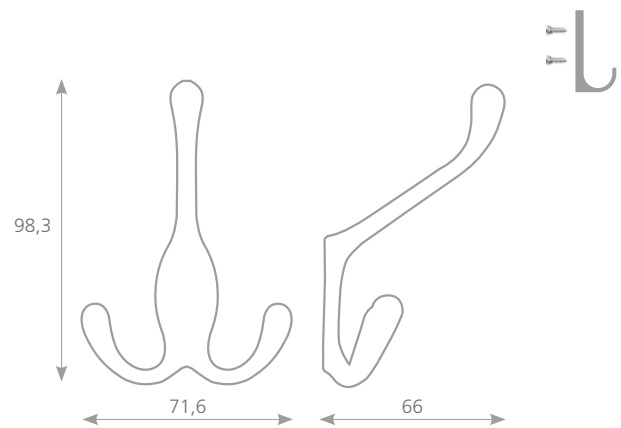

Kód / art.
226995

CARLOS

Staroměď
Old copper

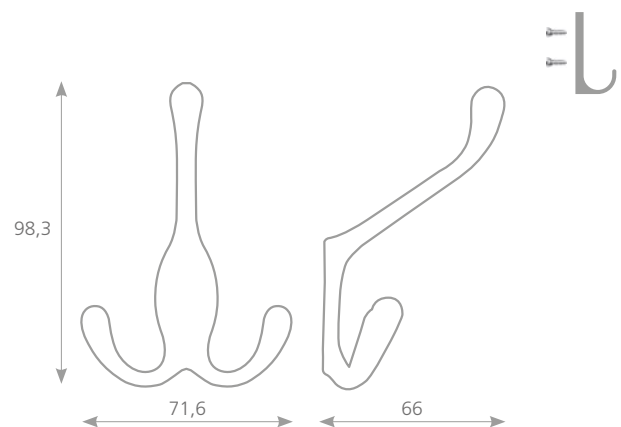

Kód / art.
226996

VĚŠÁKY

FURNITURE HOOKS

DAREC XL

Chrom
Polished chrome

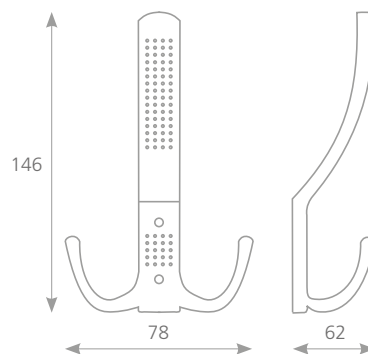

Kód / art.

08883



DAREC XL

Satin chrom
Matt chrome

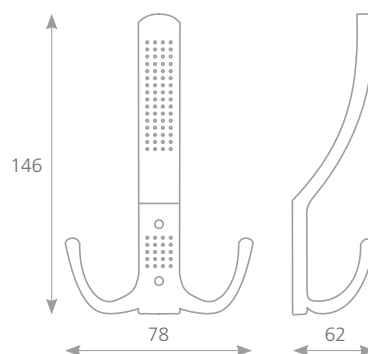

Kód / art.

224252



DAREC XL

Satin nikel
Matt nickel

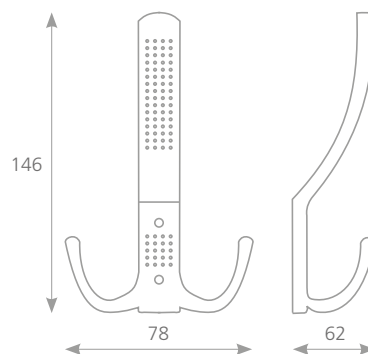

Kód / art.

224253



DAREC

Chrom
Polished chrome

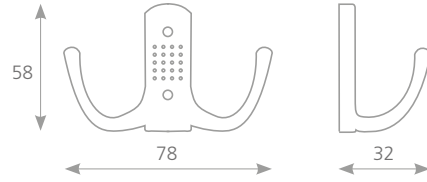

Kód / art.

08885

DAREC

Satin chrom
Matt chrome

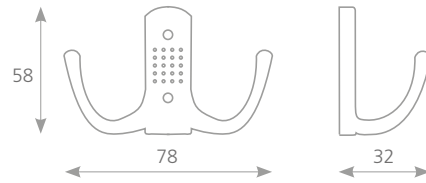

Kód / art.

224250

DAREC

Satin niki
Matt nickel

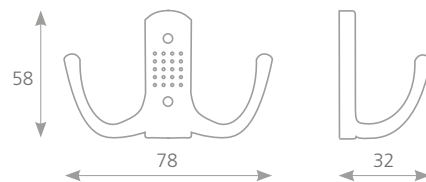

Kód / art.

224251

VĚŠÁKY

FURNITURE HOOKS

MARCEL XL

Chrom lesklý / polished chrome

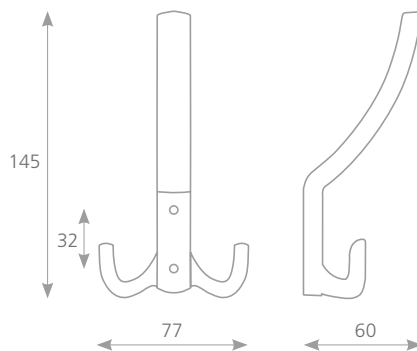

Kód / art.

224259

MARCEL XL

Satin chrom / matt chrome

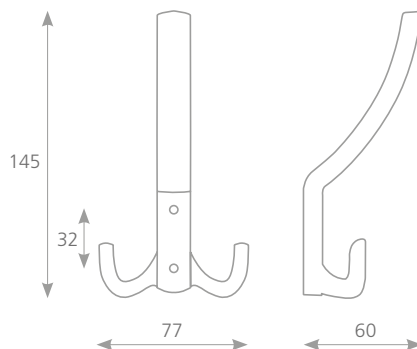

Kód / art.

224260

MARCEL XL

Satin nikl / matt nickel

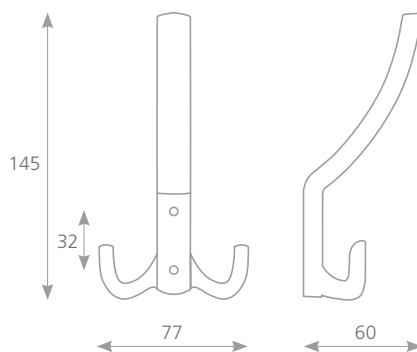

Kód / art.

224261

MARCEL S

Chrom lesklý / polished chrome

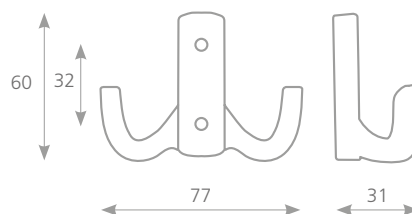

Kód / art.

224262

MARCEL S

Satin chrom / matt chrome

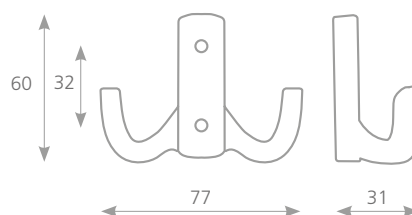

Kód / art.

224263

MARCEL S

Satin nikl / matt nickel

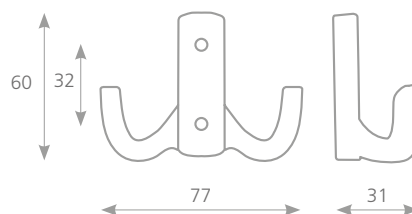

Kód / art.

224264

VĚŠÁKY

FURNITURE HOOKS

TAMOS

Satin nikel
Matt nickel

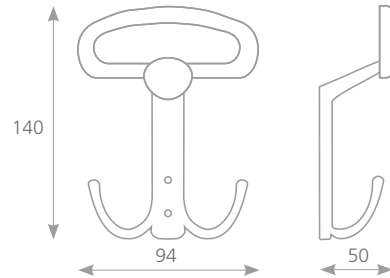

Kód / art.

35601



TAMOS

Satin chrom
Matt chrome

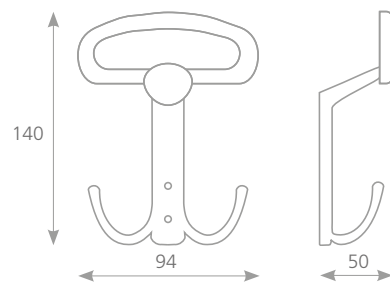

Kód / art.

35602



TRIAS

Chrom
Polished chrome

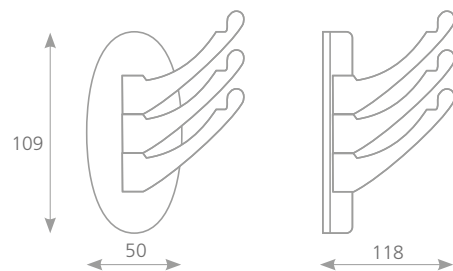

Kód / art.

08875



TRIAS

Satin nikel / matt nickel

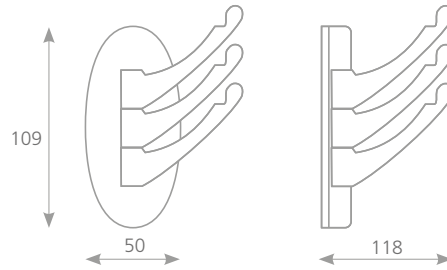

Kód / art.

08876



RAPALLO

Satin nikel / matt nickel

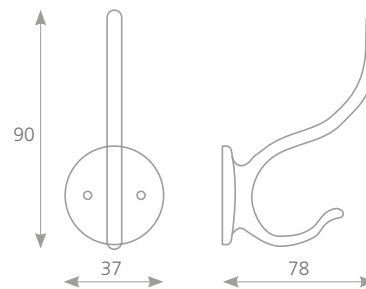

Kód / art.

35621



RAPALLO

Satin chrom / matt chrome

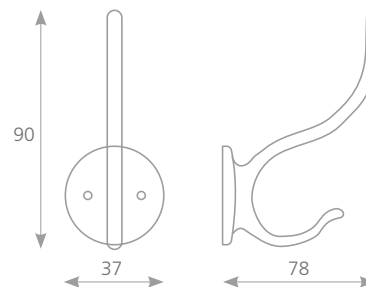
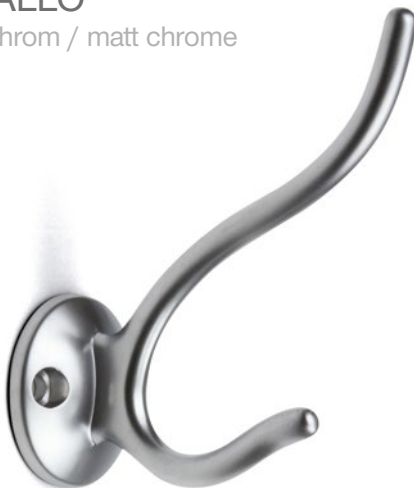

Kód / art.

35622



VĚŠÁKY

FURNITURE HOOKS

RAPALLO

Chrom / polished chrome

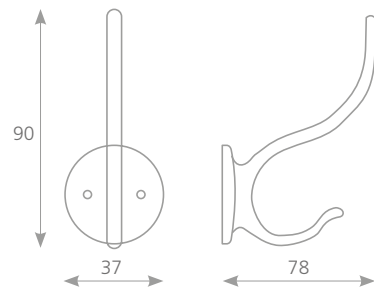

Kód / art.

35623



RAPALLO

Mosaz / brass

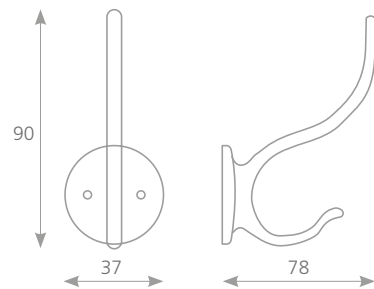

Kód / art.

35624



RAPALLO

Černá / black

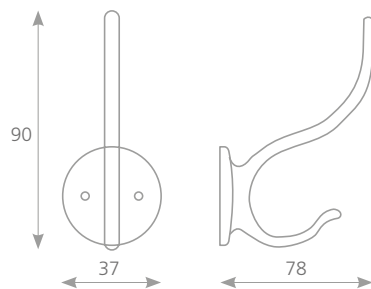

Kód / art.

35625



UNICO

Satin nikl / matt nickel

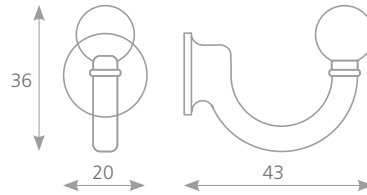

Kód / art.

35571

UNICO

Satin chrom / matt chrome

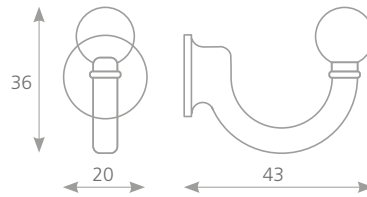

Kód / art.

35572

UNICO

Chrom / polished chrome

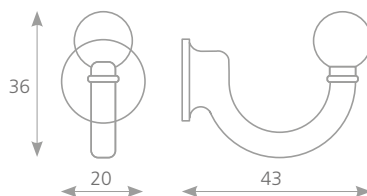

Kód / art.

35573

VĚŠÁKY

FURNITURE HOOKS

UNICO

Mosaz / brass

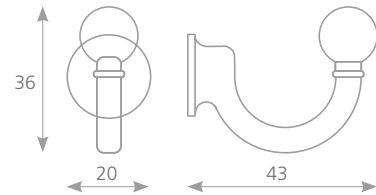

Kód / art.

35574



FERA

Satin chrom / matt chrome

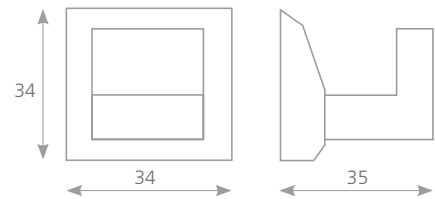

Kód / art.

35991



EMIL

Satin chrom / matt chrome

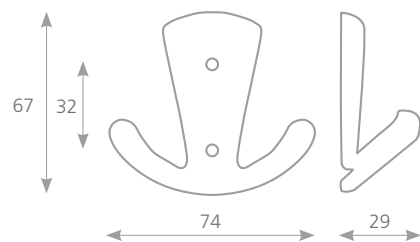

Kód / art.

224265



EMIL

satin nikl / matt nickel

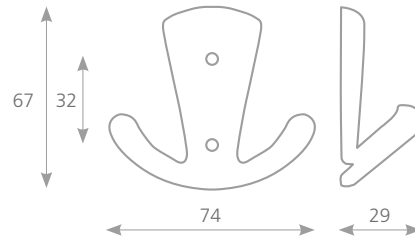

Kód / art.

224266

CARPO

Satin nikl / matt nickel

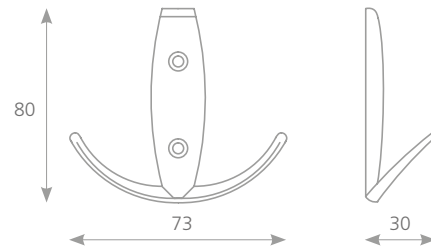

Kód / art.

157316

CARPO

Satin chrom / matt chrome

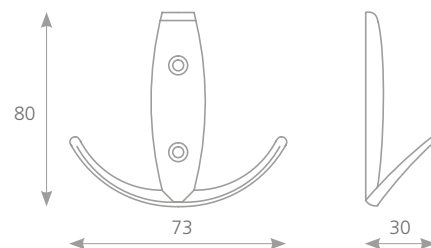

Kód / art.

157313

VĚŠÁKY

FURNITURE HOOKS

CARPO

Broušený nikel / nickel brushed

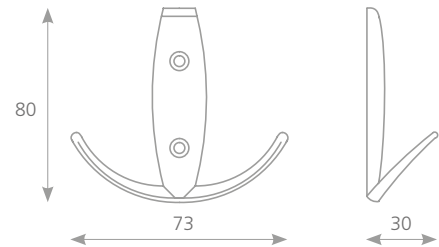

Kód / art.

157315



LIVORNO

Satin nikel / matt nickel

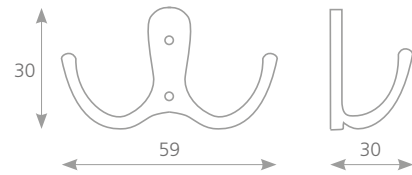

Kód / art.

35611



LIVORNO

Satin chrom / matt chrome

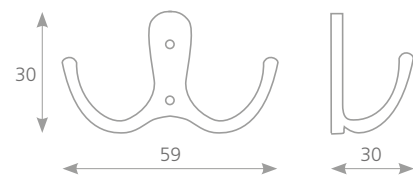

Kód / art.

35612



LIVORNO

Chrom / polished chrome

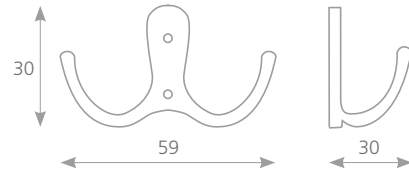

Kód / art.

35613



LIVORNO

Mosaz / brass

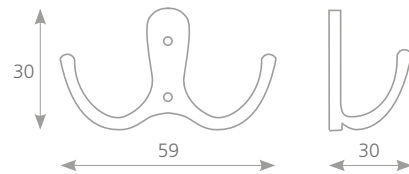

Kód / art.

35614



LIVORNO

Černá / black

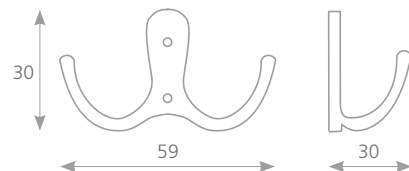

Kód / art.

35615



VĚŠÁKY

FURNITURE HOOKS

LERICO

Satin chrom / matt chrome

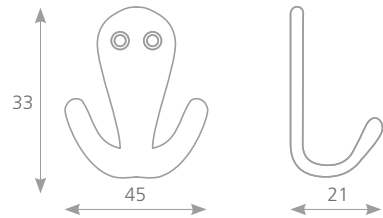

Kód / art.

157330



LERICO

Chrom / polished chrome

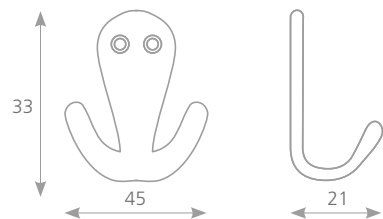

Kód / art.

157332



LERICO

Satin nikl / matt nickel

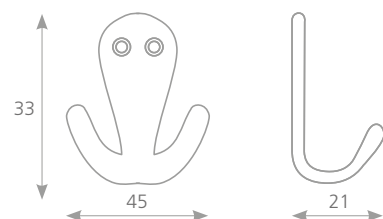

Kód / art.

157331



MUSO

Satin chrom / matt chrome

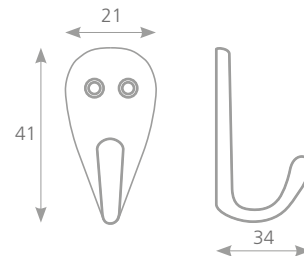

Kód / art.

157333

MUSO

Chrom / polished chrome

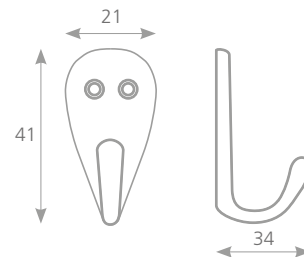

Kód / art.

157335

MUSO

Satin nikl / matt nickel

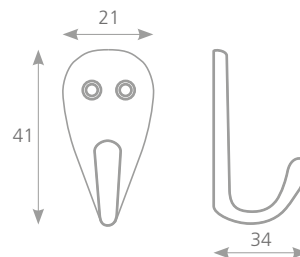

Kód / art.

157334

VĚŠÁKY

FURNITURE HOOKS

MURERO XL

Tmavá patina
Matt old black steel

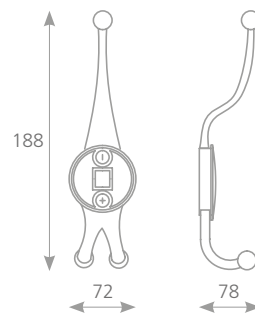

Kód / art.

157320



MURERO XL

Staromosaz / old brass

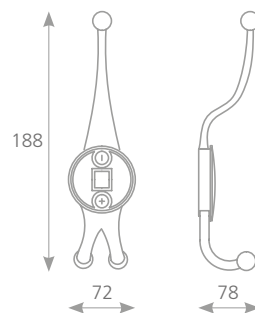

Kód / art.

157319



MURERO

Tmavá patina / matt old black steel

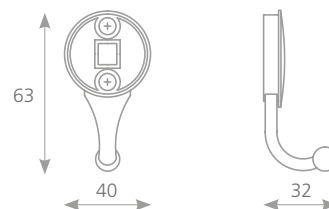

Kód / art.

157318



MURERO

Staromosaz / old brass

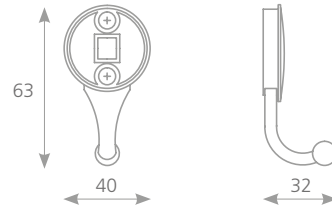

Kód / art.

157317

ORIO XL

Staromosaz
Old brass

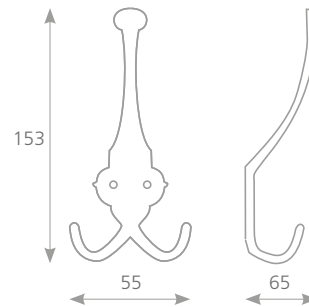

Kód / art.

36768

ORIO

Staromosaz / old brass

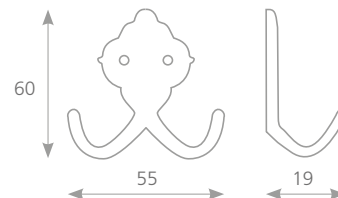

Kód / art.

36769

VĚŠÁKY

FURNITURE HOOKS

RUBICO XL

Tmavá patina
Matt old black steel

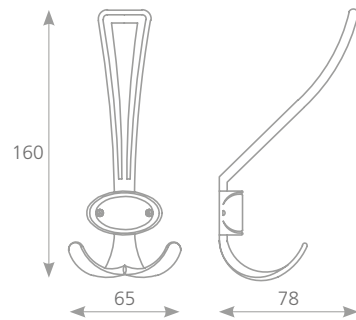

Kód / art.

157311



RUBICO XL

Staromosaz
Old brass

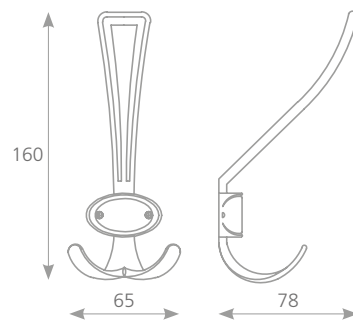

Kód / art.

157312



RUBICO XL

Staroměď
Old copper look

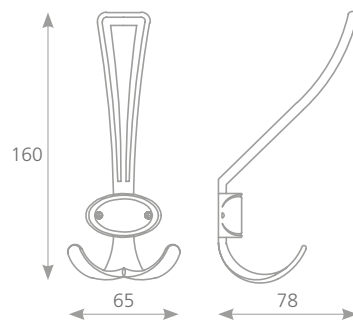

Kód / art.

205957



RUBICO XL

Starocín
Old pewter

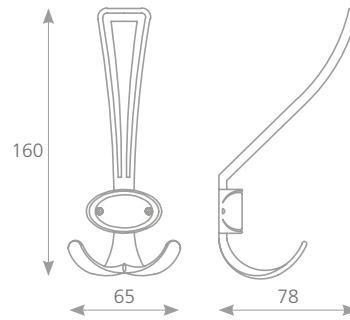

Kód / art.
226977



RUBICO XL

Staroměď broušená
Old copper brushed

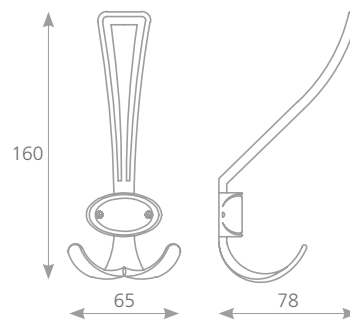

Kód / art.
226976



RUBICO

Tmavá patina
Matt old black steel

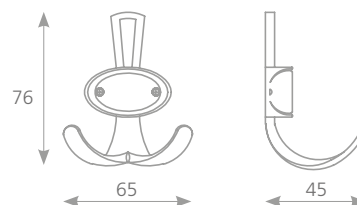

Kód / art.
157309



VĚŠÁKY

FURNITURE HOOKS

RUBICO

Starocín
Old pewter

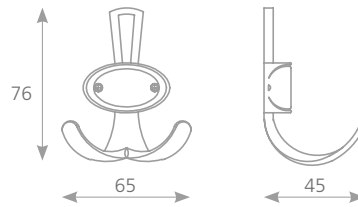

Kód / art.
226967



RUBICO

Staroměď broušená
Old copper brushed

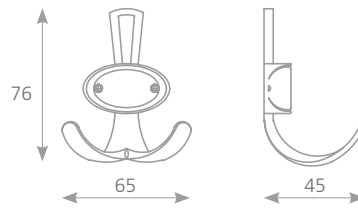

Kód / art.
226969



RUBICO

Staromosaz
Old brass

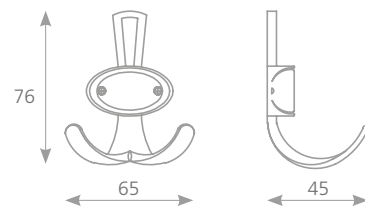

Kód / art.
157310



RUBICO

Staroměď
Old copper look

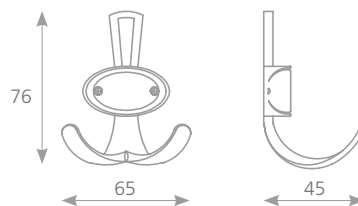

Kód / art.

205956

RUZA

Satin nikl / matt nickel

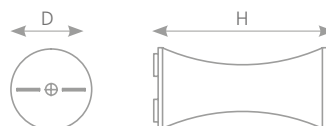

Kód / art.

157289

D

16

H

27

157294

21

35

RUZA

Satin chrom / matt chrome

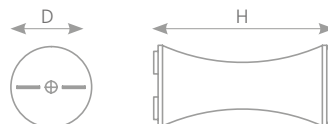

Kód / art.

157290

D

16

H

27

157295

21

35

RUZA

Chrom / polished chrome

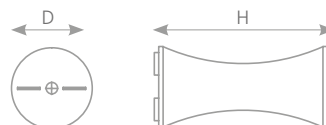

Kód / art.

157292

D

16

H

27

157297

21

35

VĚŠÁKY

FURNITURE HOOKS

RUZA

Broušený nikel / nickel brushed

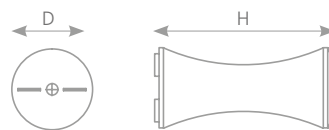

Kód / art.	D	H
157291	16	27
157296	21	35

RUZA

Černá / black

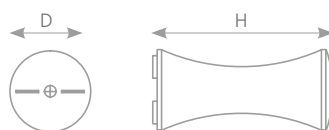

Kód / art.	D	H
157293	16	27
157299	21	35

RITTO

Hliník / aluminium

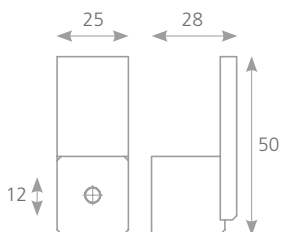

úchytka RITTO (str. 49)
pull RITTO (pg. 49)



knopka RITTO (str. 129)
knob RITTO (pg. 129)

Jen jeden montážní otvor, pro sprácnou funkci nutno přilepit.

Kód / art.

UG010

TOWELO

Hliník / aluminium

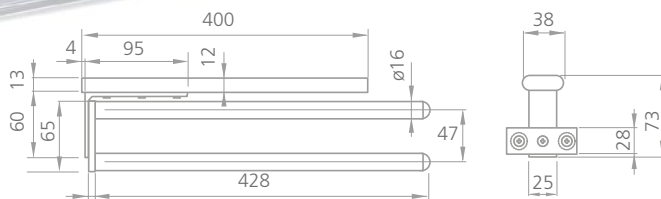

Kód / art.

36725



Příslušenství
Accessories



PŘÍSLUŠENSTVÍ

ACCESSORIES

ADAPTÉR

k uchycení úchytek na rozevírací dveře
Adaptor for the handle fixing to the folding doors leaves

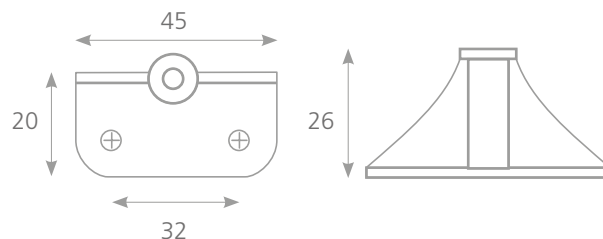

Chrom / Chrome

Satin niki / matt nickel

08880

08881

GUMOVÁ PODLOŽKA ÚCHYTKY

pro montáž do skla
Silicon washer for handle fixing to the glass door



- Pro správnou funkci použijte 2 ks podložky na jeden šroubek
- Kov nesmí přímo doléhat na sklo
- Transparentní, pro průměr šroubku 4 mm
- Use 2 washers for one screw
- Neither handle nor screw should touch the glass directly
- Transparent colour, suitable for screw M4

Kód / art.

08002

OZNAČOVACÍ ŠABLONY

pro úchytky
Marking template for handles

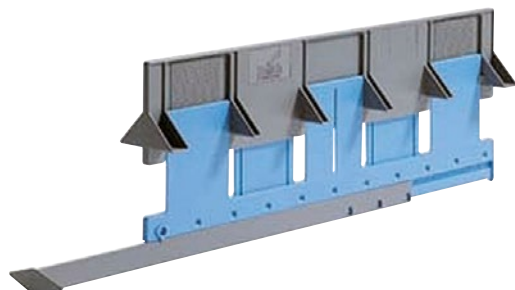

- Univerzální šablona BLUEJIG se seřízením ve dvou osách pro rychlé a přesné označení polohy otvorů
- Určeno pro úchytky v rozteči 32–320 (mm)
- Rozsah vzdáleností od boční hrany čela zásuvky po první montážní otvor úchytky 10–334 (mm)
- Rozsah vzdáleností od horní hrany čela resp. od dolní hrany čela po úchytku 20–65 (mm)
- Universal template BLUEJIG with 2 axes adjustment for fast and precise hole marking
- Intended for handles with CC distance 32–320 mm
- Distance range from side edge of the door to the first mounting hole from 10 to 334 mm
- Distance range from top/bottom edge of the door to the mounting hole from 20 to 65 mm

Kód / art.

104215

VÝSTAVNÍ STOJANY / DISPLAY PANELS

Výstavní stojany úchytek a věšáků Tulip pro zákazníky
Display panels with handles Tulip for customers

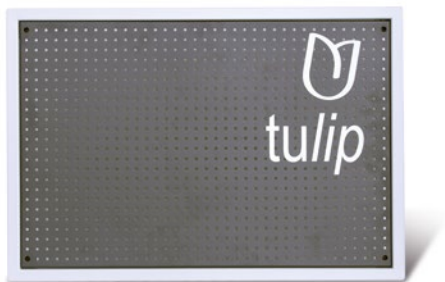

206390



206624/ 206381

Kód / art.	Verze / version
206624	standart 2 strany / standart, 2 sided
206381	standart 1 strana / standart, 1 sided
206390	rámeček / Frame 60*40 cm
206623	design 2 strany / 6 rastrů / Design version, 2-sided, 6 plates
206622	design 2 strany / 4 rastry / Design version, 2-sided, 4 plates
206376	design 1 strana / 3 rastry / Design version, 1-sided, 3 plates



206623 / 206376

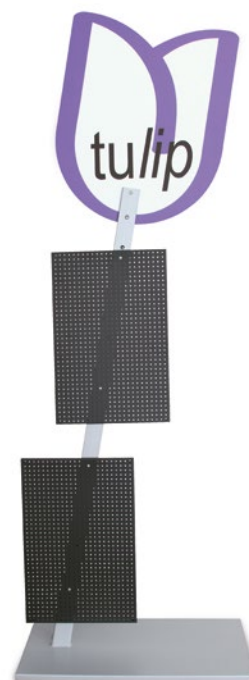

206622

Poznámky / Notes

A series of horizontal dotted lines for writing notes.

PRODUKTOVÝ KATALOG
Product catalogue

2015

