



## ORGA-LINE für TANDEMBOX



## Praktisch übersichtlich

Mit ORGA-LINE lässt sich alles schön und übersichtlich aufbewahren; selbst große Staugüter finden sicheren Stand. So bleibt alles im Überblick: Staugüter können dank ORGA-LINE sichtbar und gut sortiert untergebracht werden. Und wenn der Besuch einmal beim Kochen helfen möchte, genügt ein Griff und schon ist das richtige Gewürz zur Hand.

ORGA-LINE

1



ORGA-LINE für Kochbesteck



ORGA-LINE für offene Vorräte und Küchengeräte



ORGA-LINE für Backbleche und Backformen



ORGA-LINE für Reinigungsutensilien



ORGA-LINE-Folienschneider für Alufolie



ORGA-LINE für Arbeitsbesteck im SPACE CORNER



ORGA-LINE für den Kleiderschrank



## ORGA-LINE Schalen-Sets



- Komplett ausfüllende Schubkastensets ab Korpusbreite 275 mm
- Optimal geeignet für Essbesteck
- Herausnehmbare Schalen - geeignet für die Spülmaschine
- Schalen und Längsteiler aus hochwertigem Edelstahl, kombiniert mit strapazierfähigen Kunststoffteilen in RAL 7037 (staubgrau)
- TANDEMBOX, Höhe M/K
- Nennlängen 450-650 mm
- Empfehlung Korpusbreite 275 bis 1200 mm
- Korpusseitendicke 16-19 mm



## ORGA-LINE Schalen-Set Korpusbreite: 275-299 mm

Korpusbreite: 275-299 mm

Art.Nr.	Werk.Nr.	NL mm	ME	Preis EUR	per
103 359 103	ZSI.450BI1N	450	GT	31,54	1 GT
103 359 104	ZSI.500BI1N	500	GT	38,12	1 GT
103 359 105	ZSI.550BI1N	550	GT	45,90	1 GT
103 359 106	ZSI.600BI1N	600	GT	54,31	1 GT
103 359 107	ZSI.650BI1N	650	GT	61,80	1 GT

Produktgruppe 300 333



Symbolbild, NL 500 mm



## ORGA-LINE Schalen-Set Korpusbreite: 300-399 mm

Korpusbreite: 300-399 mm

Art.Nr.	Werk.Nr.	NL mm	ME	Preis EUR	per
103 359 108	ZSI.450BI2N	450	GT	41,97	1 GT
103 359 109	ZSI.500BI2N	500	GT	49,37	1 GT
103 359 110	ZSI.550BI2N	550	GT	57,65	1 GT
103 359 111	ZSI.600BI2N	600	GT	65,75	1 GT
103 359 112	ZSI.650BI2N	650	GT	74,04	1 GT

Produktgruppe 300 333



Symbolbild, NL 500 mm

**blum****ORGA-LINE Schalen-Set Korpusbreite: 400-549 mm**

Korpusbreite: 400-549 mm

Art.Nr.	Werk.Nr.	NL mm	ME	Preis EUR	per
103 359 113	ZSI.450BI3N	450	GT	49,10	1 GT
103 359 114	ZSI.500BI3	500	GT	61,16	1 GT
103 359 115	ZSI.550BI3	550	GT	69,30	1 GT
103 359 116	ZSI.600BI3	600	GT	81,74	1 GT
103 359 117	ZSI.650BI3	650	GT	90,17	1 GT

Produktgruppe 300 333



Symbolbild, NL 500 mm

**blum****ORGA-LINE Schalen-Set Korpusbreite: 550-599 mm**

Korpusbreite: 550-599 mm

Art.Nr.	Werk.Nr.	NL mm	ME	Preis EUR	per
103 359 118	ZSI.450BI1N + ZSI.450BI3N	450	GT	80,64	1 GT
103 359 119	ZSI.500BI1N + ZSI.500BI3	500	GT	99,28	1 GT
103 359 120	ZSI.550BI1N + ZSI.550BI3	550	GT	115,20	1 GT
103 359 121	ZSI.600BI1N + ZSI.600BI3	600	GT	136,05	1 GT
103 359 122	ZSI.650BI1N + ZSI.600BI3	650	GT	151,97	1 GT

Produktgruppe 300 333



Symbolbild, NL 500 mm

**blum****ORGA-LINE Schalen-Set Korpusbreite: 600 mm**

Korpusbreite: 600 mm

Art.Nr.	Werk.Nr.	NL mm	ME	Preis EUR	per
103 360 145	ZSI.60VEI4	450	GT	82,10	1 GT
103 360 020	ZSI.60VEI6	500	GT	101,62	1 GT
103 360 021	ZSI.60VEI7	550	GT	117,54	1 GT
103 360 033	ZSI.600BI1N + ZSI.600BI3	600	GT	136,05	1 GT
103 360 034	ZSI.650BI1N + ZSI.650BI3	650	GT	151,97	1 GT

Produktgruppe 300 333



Symbolbild, NL 500 mm

**blum****ORGA-LINE Schalen-Set Korpusbreite: 601-699 mm**

Korpusbreite: 601-699 mm

Art.Nr.	Werk.Nr.	NL mm	ME	Preis EUR	per
103 359 123	ZSI.450BI1N + ZSI.450BI3N	450	GT	80,64	1 GT
103 359 124	ZSI.500BI1N + ZSI.500BI3	500	GT	99,28	1 GT
103 359 125	ZSI.550BI1N + ZSI.550BI3	550	GT	115,20	1 GT
103 359 126	ZSI.600BI1N + ZSI.600BI3	600	GT	136,05	1 GT
103 359 127	ZSI.650BI1N + ZSI.650BI3	650	GT	151,97	1 GT

Produktgruppe 300 333



Symbolbild, NL 500 mm



## ORGA-LINE Schalen-Set Korpusbreite: 700-799 mm

Korpusbreite: 700-799 mm

Art.Nr.	Werk.Nr.	NL mm	ME	Preis EUR	per
103 360 026	ZSI.450BI2N + ZSI.450BI3N	450	GT	91,07	1 GT
103 360 027	ZSI.500BI2N + ZSI.500BI3	500	GT	110,53	1 GT
103 360 028	ZSI.550BI2N + ZSI.550BI3	550	GT	126,95	1 GT
103 360 029	ZSI.600BI2N + ZSI.600BI3	600	GT	136,05	1 GT
103 360 032	ZSI.650BI2N + ZSI.600BI3	650	GT	151,97	1 GT

Produktgruppe 300 333



Symbolbild, NL 500 mm



## ORGA-LINE Schalen-Set Korpusbreite: 800-899 mm

Korpusbreite: 800-899 mm

Art.Nr.	Werk.Nr.	NL mm	ME	Preis EUR	per
103 360 053	2 x ZSI.450BI3N	450	GT	98,20	1 GT
103 360 054	2 x ZSI.500BI3	500	GT	122,32	1 GT
103 360 057	2 x ZSI.550BI3	550	GT	138,60	1 GT
103 360 058	2 x ZSI.600BI3	600	GT	163,48	1 GT
103 360 059	2 x ZSI.650BI3	650	GT	180,34	1 GT

Produktgruppe 300 333



Symbolbild, NL 500 mm



## ORGA-LINE Schalen-Set Korpusbreite: 900 mm

Korpusbreite: 900 mm

Art.Nr.	Werk.Nr.	NL mm	ME	Preis EUR	per
103 360 148	ZSI.90VEI4	450	GT	111,50	1 GT
103 360 035	ZSI.90VEI6	500	GT	137,83	1 GT
103 360 036	ZSI.90VEI7	550	GT	157,23	1 GT
103 360 077	ZSI.600BI3 + ZSI.600KI4	600	GT	184,23	1 GT
103 360 078	ZSI.650BI3 + ZSI.650KI4	650	GT	204,22	1 GT

Produktgruppe 300 333



Symbolbild, NL 500 mm



## ORGA-LINE Schalen-Set Korpusbreite: 901-1099 mm

Korpusbreite: 901-999 mm

Art.Nr.	Werk.Nr.	NL mm	ME	Preis EUR	per
103 359 128	ZSI.450BI3N + ZSI.450KI4N	450	GT	110,19	1 GT
103 359 129	ZSI.500BI3 + ZSI.500KI4	500	GT	135,55	1 GT
103 359 131	ZSI.550BI3 + ZSI.550KI4	550	GT	154,95	1 GT
103 359 132	ZSI.600BI3 + ZSI.600KI4	600	GT	184,23	1 GT
103 359 147	ZSI.650BI3 + ZSI.650KI4	650	GT	204,22	1 GT

Produktgruppe 300 333



Symbolbild, NL 500 mm

**blum****ORGA-LINE Schalen-Set Korpusbreite: 1000-1099 mm**

Korpusbreite: 1000-1099 mm

Art.Nr.	Werk.Nr.	NL mm	ME	Preis EUR	per
103 360 099	2 x ZSI.450KI4N	450	GT	122,18	1 GT
103 360 119	2 x ZSI.500KI4	500	GT	148,78	1 GT
103 360 129	2 x ZSI.550KI4	550	GT	171,30	1 GT
103 360 130	2 x ZSI.600KI4	600	GT	204,98	1 GT
103 360 131	2 x ZSI.650KI4	650	GT	228,10	1 GT

Produktgruppe 300 333



Symbolbild, NL 500 mm

**blum****ORGA-LINE Schalen-Set Korpusbreite: 1100-1199 mm**

Korpusbreite: 1100-1199 mm

Art.Nr.	Werk.Nr.	NL mm	ME	Preis EUR	per
103 359 148	2 x ZSI.450BI3N + 1 x ZSI.450FI2N	450	GT	122,72	1 GT
103 359 149	2 x ZSI.500BI3 + 1 x ZSI.500FI2N	500	GT	149,34	1 GT
103 359 150	2 x ZSI.550BI3 + 1 x ZSI.550FI2N	550	GT	171,87	1 GT
103 359 151	2 x ZSI.600BI3 + 1 x ZSI.600FI2N	600	GT	207,81	1 GT
103 359 152	2 x ZSI.650BI3 + 1 x ZSI.650FI2N	650	GT	226,10	1 GT

Produktgruppe 300 333



Symbolbild, NL 500 mm

**blum****ORGA-LINE Schalen-Set Korpusbreite: 1200 mm**

Korpusbreite: 1200 mm

Art.Nr.	Werk.Nr.	NL mm	ME	Preis EUR	per
103 339 806 •	ZSI.12VEI6	500	ST	166,09	1 ST
103 339 807 •	ZSI.12VEI7	550	ST	191,74	1 ST
103 360 137	2 x ZSI.600BI3 + 1 x ZSI.600FI2N	600	GT	279,45	1 GT
103 360 140	2 x ZSI.650BI3 + 1 x ZSI.650FI2N	650	GT	313,19	1 GT

Produktgruppe 300 333



Symbolbild, NL 500 mm



## ORGA-LINE Facheinteilungs-Sets



1

- Komplett ausfüllende Schubkastensets ab Korpusbreite 275 mm
- Herausnehmbare Schalen - geeignet für die Spülmaschine
- Schalen und Längsteiler aus hochwertigem Edelstahl, kombiniert mit strapazierfähigen Kunststoffteilen in RAL 7037 (staubgrau)
- Folienschneider und Messerhalter optional einsetzbar
- TANDEMBOX, Höhe M/K
- Nennlängen 450-650 mm
- Empfehlung Korpusbreite 275 bis 1200 mm
- Korpusseitendicke 16-19 mm



## ORGA-LINE Facheinteilungs-Set Korpusbreite: 275-349 mm

Korpusbreite: 275-349 mm

Art.Nr.	Werk.Nr.	NL mm	ME	Preis EUR	per
103 359 153	ZSI.450BI1N	450	GT	31,54	1 GT
103 359 154	ZSI.500BI1N	500	GT	38,12	1 GT
103 359 155	ZSI.550BI1N	550	GT	45,90	1 GT
103 359 156	ZSI.600BI1N	600	GT	54,31	1 GT
103 359 157	ZSI.650BI1N	650	GT	61,80	1 GT

Produktgruppe 300 333



Symbolbild, NL 500 mm



## ORGA-LINE Facheinteilungs-Set Korpusbreite: 350-449 mm

Korpusbreite: 350-449 mm

Art.Nr.	Werk.Nr.	NL mm	ME	Preis EUR	per
103 359 158	ZSI.450KI2N	450	GT	43,19	1 GT
103 359 159	ZSI.500KI2N	500	GT	51,02	1 GT
103 359 161	ZSI.550KI2N	550	GT	61,92	1 GT
103 359 162	ZSI.600KI2N	600	GT	74,73	1 GT
103 359 163	ZSI.650KI2N	650	GT	85,34	1 GT

Produktgruppe 300 333



Symbolbild, NL 500 mm

**ORGA-LINE Facheinteilungs-Set Korpusbreite: 450-599 mm**

Korpusbreite: 450-599 mm

Art.Nr.	Werk.Nr.	NL mm	ME	Preis EUR	per
103 359 164	ZSI.450FI2N	450	GT	24,52	1 GT
103 359 166	ZSI.500FI2N	500	GT	27,02	1 GT
103 359 167	ZSI.550KI2N	550	GT	33,27	1 GT
103 359 168	ZSI.600FI2N	600	GT	44,33	1 GT
103 359 169	ZSI.650FI2N	650	GT	45,76	1 GT

Produktgruppe 300 333



Symbolbild, NL 500 mm

**ORGA-LINE Facheinteilungs-Set Korpusbreite: 600 mm**

Korpusbreite: 600 mm

Art.Nr.	Werk.Nr.	NL mm	ME	Preis EUR	per
103 360 149	ZSI.60VUI4	450	GT	77,80	1 GT
103 360 070	ZSI.60VUI6	500	GT	93,09	1 GT
103 360 071	ZSI.60VUI7	550	GT	111,77	1 GT
103 360 049	ZSI.600BI1N + ZSI.600KI3N	600	GT	128,78	1 GT
103 360 052	ZSI.650BI1N + ZSI.650KI3N	650	GT	146,89	1 GT

Produktgruppe 300 333



Symbolbild, NL 500 mm

**ORGA-LINE Facheinteilungs-Set Korpusbreite: 601-699 mm**

Korpusbreite: 601-699 mm

Art.Nr.	Werk.Nr.	NL mm	ME	Preis EUR	per
103 359 170	ZSI.450BI1N + ZSI.450KI3N	450	GT	75,75	1 GT
103 359 171	ZSI.500BI1N + ZSI.500KI3N	500	GT	90,16	1 GT
103 359 172	ZSI.550BI1N + ZSI.550KI3N	550	GT	108,84	1 GT
103 359 173	ZSI.600BI1N + ZSI.600KI3N	600	GT	128,78	1 GT
103 359 184	ZSI.650BI1N + ZSI.650KI3N	650	GT	146,89	1 GT

Produktgruppe 300 333



Symbolbild, NL 500 mm

**ORGA-LINE Facheinteilungs-Set Korpusbreite: 700-799 mm**

Korpusbreite: 700-799 mm

Art.Nr.	Werk.Nr.	NL mm	ME	Preis EUR	per
103 359 185	ZSI.450KI2N + ZSI.450KI3N	450	GT	87,40	1 GT
103 359 186	ZSI.500KI2N + ZSI.500KI3N	500	GT	103,06	1 GT
103 359 187	ZSI.550KI2N + ZSI.550KI3N	550	GT	124,86	1 GT
103 359 188	ZSI.600KI2N + ZSI.600KI3N	600	GT	149,20	1 GT
103 359 189	ZSI.650KI2N + ZSI.650KI3N	650	GT	170,43	1 GT

Produktgruppe 300 333



Symbolbild, NL 500 mm





## ORGA-LINE Facheinteilungs-Set Korpusbreite: 800-899 mm

Korpusbreite: 800-899 mm

Art.Nr.	Werk.Nr.	NL mm	ME	Preis EUR	per
103 360 068	2 x ZSI.450KI3N	450	GT	88,42	1 GT
103 360 069	2 x ZSI.500KI3N	500	GT	104,08	1 GT
103 360 072	2 x ZSI.550KI3N	550	GT	125,88	1 GT
103 360 073	2 x ZSI.600KI3N	600	GT	148,94	1 GT
103 360 074	2 x ZSI.650KI3N	650	GT	170,18	1 GT

Produktgruppe 300 333



Symbolbild, NL 500 mm

1



## ORGA-LINE Facheinteilungs-Set Korpusbreite: 900 mm

Korpusbreite: 900 mm

Art.Nr.	Werk.Nr.	NL mm	ME	Preis EUR	per
103 360 086	ZSI.90VUI4	450	ST	106,09	1 ST
103 360 080	ZSI.90VUI6	500	GT	122,99	1 GT
103 360 081	ZSI.90VUI7	550	GT	147,92	1 GT
103 360 079	2 x ZSI.600KI3N	600	GT	148,94	1 GT
103 360 082	2 x ZSI.650KI3N	650	GT	170,18	1 GT

Produktgruppe 300 333



Symbolbild, NL 500 mm



## ORGA-LINE Facheinteilungs-Set Korpusbreite: 901-999 mm

Korpusbreite: 901-999 mm

Art.Nr.	Werk.Nr.	NL mm	ME	Preis EUR	per
103 359 190	2 x ZSI.450KI3N	450	GT	88,42	1 GT
103 359 191	2 x ZSI.500KI3N	500	GT	104,08	1 GT
103 359 192	2 x ZSI.550KI3N	550	GT	125,88	1 GT
103 359 193	2 x ZSI.600KI3N	600	GT	148,94	1 GT
103 359 194	2 x ZSI.650KI3N	650	GT	170,18	1 GT

Produktgruppe 300 333



Symbolbild, NL 500 mm



## ORGA-LINE Facheinteilungs-Set Korpusbreite: 1000-1099 mm

Korpusbreite: 1000-1099 mm

Art.Nr.	Werk.Nr.	NL mm	ME	Preis EUR	per
103 360 132	2 x ZSI.450KI2N + 1 x ZSI.450FI3	450	GT	122,16	1 GT
103 360 133	2 x ZSI.500KI2N + 1 x ZSI.500FI3	500	GT	141,56	1 GT
103 360 134	2 x ZSI.550KI2N + 1 x ZSI.550FI3	550	GT	172,73	1 GT
103 360 135	2 x ZSI.600KI2N + 1 x ZSI.600FI3	600	GT	220,28	1 GT
103 360 136	2 x ZSI.650KI2N + 1 x ZSI.650FI3	650	GT	241,50	1 GT

Produktgruppe 300 333



Symbolbild, NL 500 mm

**ORGA-LINE Facheinteilungs-Set Korpusbreite: 1100-1199 mm**

Korpusbreite: 1100-1199 mm

Art.Nr.	Werk.Nr.	NL mm	ME	Preis EUR	per
103 359 195	2 x ZSI.450KI3N + 1 x SI.450FI2N	450	GT	112,94	1 GT
103 359 196	2 x ZSI.500KI3N + 1 x ZSI.500FI2N	500	GT	143,60	1 GT
103 359 197	2 x ZSI.550KI3N + 1 x ZSI.550FI2N	550	GT	159,15	1 GT
103 359 198	2 x ZSI.600KI3N + 1 x ZSI.600FI2N	600	GT	193,27	1 GT
103 359 199	2 x ZSI.650KI3N + 1 x ZSI.650FI2N	650	GT	215,94	1 GT

Produktgruppe 300 333



Symbolbild, NL 500 mm

**ORGA-LINE Facheinteilungs-Set Korpusbreite: 1200 mm**

Korpusbreite: 1200 mm

Art.Nr.	Werk.Nr.	NL mm	ME	Preis EUR	per
103 360 094 •	ZSI.12VUI4	450	ST	129,62	1 ST
103 360 095 •	ZSI.12VUI6	500	ST	149,02	1 ST
103 360 096 •	ZSI.12VUI7	550	ST	180,20	1 ST
103 360 141	2 x ZSI.600KI3N + 1 x ZSI.600FI3	600	GT	210,39	1 GT
103 360 144	2 x ZSI.650KI3N + 1 x ZSI.650FI3	650	GT	241,00	1 GT

Produktgruppe 300 333



Symbolbild, NL 500 mm



**ORGA-LINE Schalen**

- Spülmaschinenfest bis + 65° C

Material: Kunststoff/Edelstahl (Inox)

Art.Nr.	Werk.Nr.	L x B x H mm	ME	Preis EUR	per
103 359 270	ZSI.010SI	88 x 88 x 60	ST	4,06	1 ST
103 359 271	ZSI.020SI	176 x 88 x 60	ST	5,27	1 ST
103 359 272	ZSI.030SI	264 x 88 x 60	ST	6,04	1 ST
103 359 273	ZSI.040SI	352 x 88 x 60	ST	9,27	1 ST

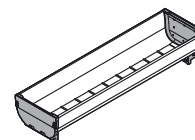
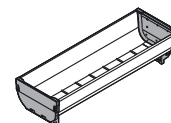
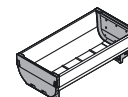
Produktgruppe 300 333



**ORGA-LINE Querteiler**

- Flexible Querteiler

Material: Kunststoff

Art.Nr.	Werk.Nr.	Abmessung mm	ME	Preis EUR	per
103 359 275	ZSI.010Q	88 x 64	ST	1,27	1 ST
103 359 276	ZSI.020Q	176 x 64	ST	1,91	1 ST

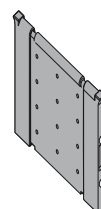
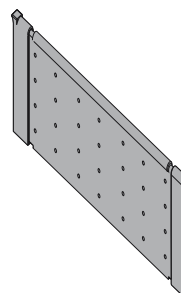
Produktgruppe 300 333





**ORGA-LINE Organisationselemente für den TANDEMBOX antaro Frontauszug**

- Flexibles Einteilungssystem
- Reinigungsfreundlich

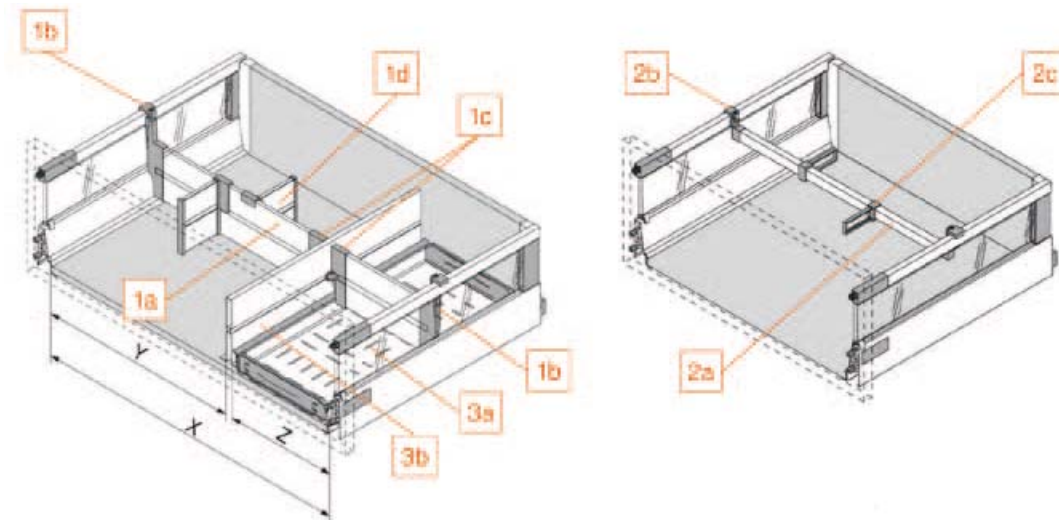

Höhe C



Höhe D





## ORGA-LINE Querteiler ablängbar

- Höhe 110,4 mm
- Auf Zwischenmaße ablängbar

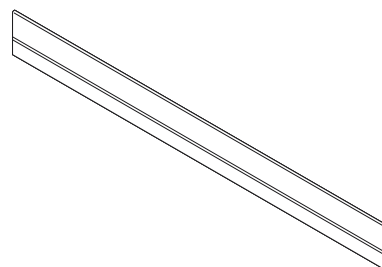

### Zuschnitt:

- X = Lichte Weite - 91 mm
- Y = Lichte Weite - 295 mm (KB 275)
- Y = Lichte Weite - 320 mm (KB 300)
- Z = 152 mm (KB 275)
- Z = 177 mm (KB 300)

Legende: 1a  
Verwendung: TANDEMBOX antaro

Art.Nr.	Werk.Nr.	KB mm	Länge mm	Material	ME	Preis EUR	per
103 338 953	Z40L177A	300	177	Aluminium terraschwarz	ST	7,37	1 ST
103 338 957	Z40L477A	600	477	Aluminium terraschwarz	ST	9,31	1 ST
103 338 961	Z40L777A	900	777	Aluminium terraschwarz	ST	13,75	1 ST
103 339 291	Z40L1077A	1200	1077	Aluminium terraschwarz	ST	21,39	1 ST
103 338 952	Z40L177A	300	177	Aluminium seidenweiß	ST	7,37	1 ST
103 338 956	Z40L477A	600	477	Aluminium seidenweiß	ST	9,31	1 ST
103 338 960	Z40L777A	900	777	Aluminium seidenweiß	ST	13,74	1 ST
103 339 290	Z40L1077A	1200	1077	Aluminium seidenweiß	ST	21,39	1 ST
103 338 951	Z40L177A	300	177	Aluminium grau RAL 9006	ST	7,37	1 ST
103 338 955	Z40L477A	600	477	Aluminium grau RAL 9006	ST	9,31	1 ST
103 338 959	Z40L777A	900	777	Aluminium grau RAL 9006	ST	13,73	1 ST
103 339 319	Z40L1077A	1200	1077	Aluminium grau RAL 9006	ST	21,39	1 ST
103 339 019	Z40L177A	300	177	Aluminium vernickelt matt	ST	41,02	1 ST
103 339 029	Z40L477A	600	477	Aluminium vernickelt matt	ST	43,37	1 ST
103 339 039	Z40L777A	900	777	Aluminium vernickelt matt	ST	48,07	1 ST
103 339 049	Z40L1077A	1200	1077	Aluminium vernickelt matt	ST	53,71	1 ST

Produktgruppe 300 333



## ORGA-LINE Querteiler Aufnahme

Legende: 1b  
Verwendung: TANDEMBOX antaro

Art.Nr.	Werk.Nr.	Höhe	Material	ME	Preis EUR	per
103 339 336	Z40C0002Z	C	Kunststoff terraschwarz	ST	2,18	1 ST
103 339 340	Z40D0002Z	D	Kunststoff terraschwarz	ST	2,36	1 ST
103 339 342	Z40D0002Z	D	Kunststoff Staubgrau RAL 7037	ST	2,36	1 ST
103 339 338	Z40C0002Z	C	Kunststoff staubgrau RAL 7037	ST	2,18	1 ST
103 339 335	Z40C0002Z	C	Kunststoff seidenweiß	ST	2,18	1 ST
103 339 339	Z40D0002Z	D	Kunststoff seidenweiß	ST	2,36	1 ST
103 339 337	Z40C0002Z	C	Kunststoff grau RAL 9006	ST	2,18	1 ST
103 339 341	Z40D0002Z	D	Kunststoff grau RAL 9006	ST	2,36	1 ST

Produktgruppe 300 336

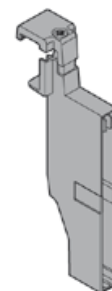



## ORGA-LINE Querteiler Aufnahme Zwischenwand

- ORGA-LINE Querteiler Aufnahme für TANDEMBOX mit Zwischenwand.

### Hinweis:

Der Einsatz bei TANDEMBOX antaro ist nur in Kombination mit einer Zwischenwand möglich.

Legende: 1c  
Verwendung: TANDEMBOX antaro

Art.Nr.	Werk.Nr.	Material	ME	Preis EUR	per
103 339 294	Z40L0002	Kunststoff terraschwarz	ST	2,36	1 ST
103 339 293	Z40L0002	Kunststoff seidenweiß	ST	2,36	1 ST
103 338 962	Z40L0002	Kunststoff grau RAL 9006	ST	2,36	1 ST
103 339 295	Z40L0002	Kunststoff grau RAL 7037	ST	2,36	1 ST

Produktgruppe 300 333

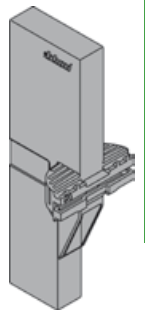

1



## ORGA-LINE Längsteiler

Legende: 1d  
Verwendung: TANDEMBOX antaro

Art.Nr.	Werk.Nr.	Material	ME	Preis EUR	per
103 339 298	Z43L100I	Edelstahl (Inox)	ST	8,62	1 ST
103 339 297	Z43L100S	Stahl terraschwarz	ST	4,39	1 ST
103 339 296	Z43L100S	Stahl seidenweiß	ST	4,39	1 ST
103 339 299	Z43L100S	Stahl grau RAL 9006	ST	4,39	1 ST

Produktgruppe 300 336

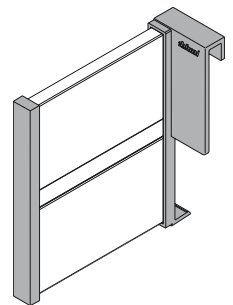

## ORGA-LINE Querreling

- Zum Ablängen
- Max. Korpusbreite 1200 mm

### Hinweis:

Zuschnitt: Lichte Korpuweite - 63 mm

Legende: 2a  
Verwendung: TANDEMBOX antaro

Art.Nr.	Werk.Nr.	Länge mm	Material	ME	Preis EUR	per
103 339 179	ZRG.1104Q	1104	Aluminium vernickelt matt	ST	25,53	1 ST
103 359 302	ZRG.1104Q	1104	Aluminium terraschwarz	ST	5,84	1 ST
103 359 301	ZRG.1104Q	1104	Aluminium seidenweiß	ST	5,84	1 ST
103 359 303	ZRG.1104Q	1104	Aluminium grau RAL 9006	ST	5,84	1 ST

Produktgruppe 300 333

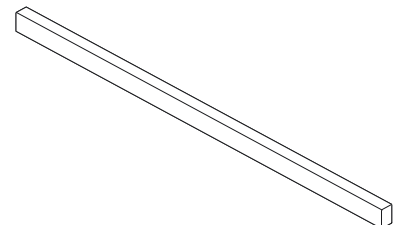

## ORGA-LINE Querreling Aufnahme

Legende: 2b  
Verwendung: TANDEMBOX antaro

Art.Nr.	Werk.Nr.	Material	ME	Preis EUR	per
103 359 330	ZRU.01E0	Kunststoff terraschwarz	ST	1,89	1 ST
103 359 332	ZRU.01E0	Kunststoff staubgrau RAL 7037	ST	1,89	1 ST
103 359 329	ZRU.01E0	Kunststoff seidenweiß	ST	1,89	1 ST
103 359 331	ZRU.01E0	Kunststoff grau RAL 9006	ST	1,89	1 ST

Produktgruppe 300 336





## ORGA-LINE Längsteiler Querreling

Legende: 2c  
Verwendung: TANDEMBOX antaro

Art.Nr.	Werk.Nr.	Material	ME	Preis EUR	per
103 359 356	ZRU.11F0	Kunststoff terraschwarz	ST	1,08	1 ST
103 359 358	ZRU.11F0	Kunststoff staubgrau RAL 7037	ST	1,08	1 ST
103 359 355	ZRU.11F0	Kunststoff seidenweiß	ST	1,08	1 ST
103 359 357	ZRU.11F0	Kunststoff grau RAL 9006	ST	1,08	1 ST

Produktgruppe 300 333

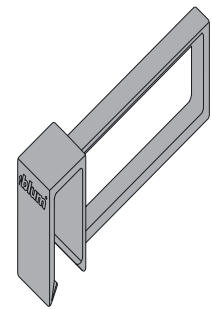

## ORGA-LINE Flaschenwanne

Legende: 3a  
Korpusbreite: 300 mm  
Material: Edelstahl (Inox)

Art.Nr.	Werk.Nr.	NL mm	ME	Preis EUR	per
103 354 666	Z48.30B016	500	ST	61,21	1 ST
103 354 667	Z48.30B017	550	ST	69,48	1 ST
103 354 683	Z48.30B018	600	ST	77,76	1 ST
103 354 668	Z48.30B019	650	ST	86,04	1 ST

Produktgruppe 300 333

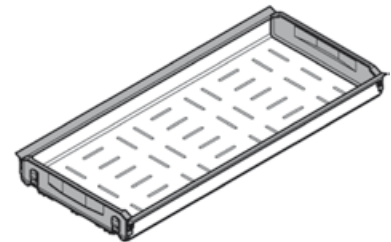

## ORGA-LINE Zwischenwand

- Höhe 151 mm
- Befestigungsart zum Anschrauben

**Hinweis:**  
Ab Korpusbreite 900 mm werden 2 Zwischenwände empfohlen.

Legende: 3b  
Verwendung: TANDEMBOX antaro

Art.Nr.	Werk.Nr.	NL mm	Material	ME	Preis EUR	per
103 339 300	Z46L420S	450	Stahl seidenweiß	ST	35,51	1 ST
103 339 301	Z46L470S	500	Stahl seidenweiß	ST	36,64	1 ST
103 339 302	Z46L520S	550	Stahl seidenweiß	ST	38,25	1 ST
103 339 303	Z46L570S	600	Stahl seidenweiß	ST	39,86	1 ST
103 339 304	Z46L620S	650	Stahl seidenweiß	ST	41,47	1 ST
103 339 343	Z46L420S	450	Stahl grau RAL 9006	ST	35,51	1 ST
103 339 344	Z46L470S	500	Stahl grau RAL 9006	ST	36,64	1 ST
103 339 345	Z46L520S	550	Stahl grau RAL 9006	ST	38,25	1 ST
103 339 346	Z46L570S	600	Stahl grau RAL 9006	ST	39,86	1 ST
103 339 347	Z46L620S	650	Stahl grau RAL 9006	ST	41,47	1 ST

Produktgruppe 300 336

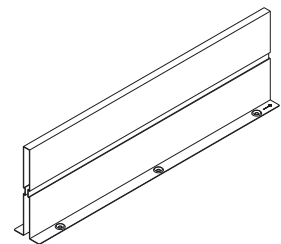



## ORGA-LINE Gewürzhalter

- Rutschsicherung durch flexible Bodenbefestigung
- Herausnehmbar
- Für alle Gewürzbehältergrößen

Material: Kunststoff staubgrau RAL 7037/Edelstahl (Inox)

Art.Nr.	Werk.Nr.	KB mm	Breite mm	ME	Preis EUR	per
103 359 313	ZFZ.30G0I	300	212	ST	21,69	1 ST
103 359 314	ZFZ.40G0I	400	312	ST	28,92	1 ST
103 359 315	ZFZ.45G0I	450	362	ST	33,78	1 ST

Produktgruppe 300 333

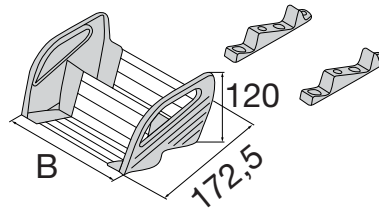

1



## ORGA-LINE Messerhalter

- Für vier große und fünf kleine Messer
- Kompatibel mit ORGA-LINE Inneneinteilung (2er Raster)
- Spülmaschinengeeignet bis 65° C

Material: Kunststoff staubgrau RAL7037/Edelstahl (Inox)

Art.Nr.	Werk.Nr.	Abmessung mm	ME	Preis EUR	per
103 359 350	ZSZ.02M0	B x T = 177,5 x 260	ST	25,44	1 ST

Produktgruppe 300 333

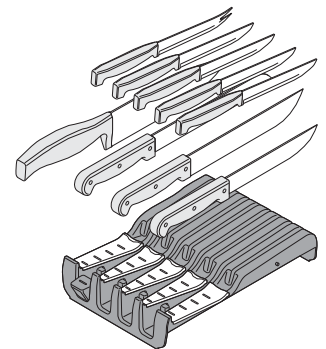

## Blum Tellerhalter

- Ermöglicht die sichere Aufbewahrung im Frontauszug für bis zu 12 Teller
- Stufenlos von 186-322 mm für die jeweilige Tellerdimension einstellbar
- Für runde und eckige Teller geeignet
- Sicherer Stand durch integrierte GummifüÙe
- Langlebig durch hochwertigen Kunststoff und Antifingerprint-beschichtetes Inox

Höhe: 170 mm

Art.Nr.	Werk.Nr.	Material	ME	Preis EUR	per
103 367 890	ZC7T0350	Kunststoff oriongrau matt/Edelstahl (Inox)	ST	43,29	1 ST

Produktgruppe 300 333





## ORGA-LINE Folienschneider für Frischhaltefolie

- Folienschneider nur für Frischhaltefolie
- Herausnehmbar durch flexible Bodenbefestigung

### Passend für Schubkästen in den Nennlängen:

450 - 650 mm bei TANDEMBOX  
500 - 650 mm bei TANDEM

### Lieferumfang:

Inkl. Folie

Material: Kunststoff, Stahl staubgrau RAL 7037

Art.Nr.	Werk.Nr.	Abmessung mm	ME	Preis EUR	per
103 359 351	ZSZ.01F0	L x B x H = 411 x 88,5 x 69,3	ST	42,13	1 ST

Produktgruppe 300 333



## ORGA-LINE Folienschneider für Alufolie

- Folienschneider nur für Alufolie
- Herausnehmbar durch flexible Bodenbefestigung

### Passend für Schubkästen in den Nennlängen:

450 - 650 mm bei TANDEMBOX  
500 - 650 mm bei TANDEM

### Lieferumfang:

Inkl. Folie

Material: Kunststoff, Stahl, Aluminium staubgrau RAL7037

Art.Nr.	Werk.Nr.	Abmessung mm	ME	Preis EUR	per
103 359 352	ZSZ.02F0	L x B x H = 411 x 88,5 x 69,3	ST	39,50	1 ST

Produktgruppe 300 333

